

# PLEASURECRAFT MARINE

## *Engine Owners Manual*

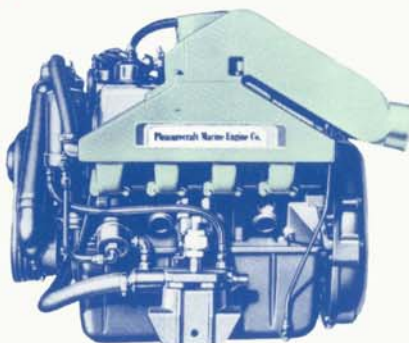

**PLEASURECRAFT  
MODEL 302/2A**



**PLEASURECRAFT  
MODEL 351/4**

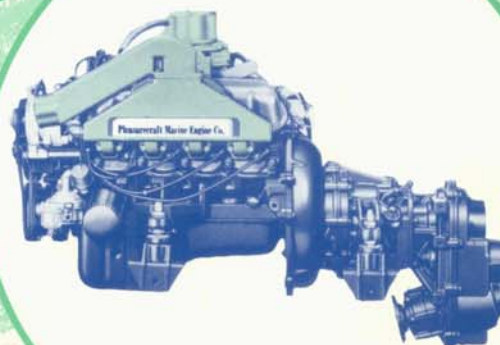

**PLEASURECRAFT  
MODEL 302/4**

## STATEMENT OF LIMITED WARRANTY

The Pleasurecraft Marine Engine Co warrants its new products to be free from defects in material and workmanship under normal use and service conditions, to the first registered owner or user. Covered under the Pleasurecraft warranty are all Pleasurecraft supplied components, except for those components warranted by Pleasurecraft Suppliers. The obligation of Pleasurecraft shall be limited to the repair or replacement, at its option, of any part or parts which have failed during the period of warranty and which Pleasurecraft's examination shall disclose to have failed due to defective material and/or workmanship.

### WARRANTY PERIOD

This warranty shall be valid to the first registered owner or user only, for the period specified below.

All components, other than those itemized below, are warranted for a period of one (1) year from the date of delivery to the first registered owner, or until the expiration of 200 hours of operation, whichever occurs first, in non-commercial use. In case of commercial use, said warranty shall be for a period of six (6) months from the date of delivery to the first user or registered owner or until the expiration of 200 hours of use or whichever occurs first.

Exceptions to the one (1) year/200 hour warranty;

- (A) Water pump impellers not covered by warranty.
- (B) Electrical system and fuel system warranty is for a period of 90 days from the date of delivery or first use.
- (C) Seals, gaskets, o-rings and other material affected by time are not covered by this warranty if their effectiveness is reduced by an extended storage period prior to sale and/or use.
- (D) Components supplied by the Ford Motor Co. are warranted by the Industrial Engine Division of the Ford Motor Co.

### MANNER OF PERFORMANCE OF WARRANTY

Service under the terms of this warranty must be performed by an authorized Pleasurecraft Marine dealer or distributor without charge for replacement parts or established flat rate labor, excepting miscellaneous items not considered as warranty defects, such as, but not limited to, lubricants, spark plugs, points, and other items which are normally frequently replaced as part of normal maintenance. Charges for additional non-warranty work and/or additional dealer charges relative to warranty work in excess of flat rate must be paid for by the owner.

Prior authorization in writing must be obtained for any warranty repairs over \$50.00 and in all cases where customer fails to establish purchase and warranty expiration date with the Warranty Identification Card sent the owner upon receipt of his warranty registration form by Pleasurecraft. The product warranty is not in effect and, therefore, cannot be honored until the product purchase date can be confirmed by Pleasurecraft.

### FAILURE EXCLUDED FROM WARRANTY

This Warranty will not apply to any failure which results from accidents, sinking, fire, neglect, abuse, or abnormal service, such as racing, towing or operating in water of insufficient depth, or to any failure resulting from improper installation, improper adjustments or improper delivery service, or to any failure resulting from the use of parts, fuels, oils or lubricants not suitable for use with the product and/or material not approved by Pleasurecraft Marine Engine Co. This warranty does not apply to any engine or drive which has been modified, or altered, or repaired in such a manner as, in the opinion of Pleasurecraft Marine Engine Co., to affect its stability, reliability, or performance. Also, excluded from warranty are all consequential and/or subsequent losses including but not limited to, loss of use, loss of income, inconvenience, trailering, towing, haul out, launch and/or any other in and out of water expenses, storage charges, dockage charges, expenses to deliver or pick-up the product being warranted to and from the warranty dealer, telephone expenses, telegraph expenses, lodging expenses, travel expenses, mechanics travel time and mileage, personal property damage, damage caused by any occurrence of an insurable nature, rental of substitute equipment of any type, removal and replacement and/or modification of any boat parts to facilitate repairs, moving of furniture, carpets, cleaning, painting, carpenter work, pre-delivery services, repairs resulting from modifications or improper repairs performed by authorized or unauthorized facility or from use of non-approved parts. Failures due to use of non-recommended lubricants or fuels, or failure to follow maintenance or lubrication schedules. Failures caused or contributed to by contaminated fuel, failures caused by improper installation or misapplication of the engine or drive, failures resulting from owners or operators failure to exercise due or normal care and precaution, components and/or assemblies that are warranted by Pleasurecraft Marine Engine Co. suppliers.

### OWNER'S RESPONSIBILITY

The above Warranty shall be conditional upon owner's compliance with the following conditions:

1. Owner shall verify that the pre-delivery service has been performed, all requested information is recorded and that the selling dealer has signed the warranty registration.
2. Owner shall promptly mail the warranty registration to Pleasurecraft Marine Engine Co. after accepting delivery.
3. Owner shall follow the instructions in the owner's manual regarding operation, break-in, lubrication, and fuel.
4. Owner shall follow maintenance schedule, operating, limits, and lay-up instructions, as outlined in the owner's manual.

### NO OTHER WARRANTY GIVEN

No other warranty, whether of mercantability, fitness or otherwise, express or implied in fact or by law, is given by Pleasurecraft Marine Engine Co. with respect to any product of the Pleasurecraft Marine Engine Co., and no other or further obligation or liability shall be incurred by Pleasurecraft Marine Engine Co. by reason of manufacture, sale, lease or use of any such product.

The obligations of Pleasurecraft Marine Engine Co. set forth in the first paragraph above shall be the exclusive remedy for any breach of warranty hereunder. In no event shall Pleasurecraft Marine Engine Co. be liable for general, consequential or incidental damages, including without limitation, any damages for personal injury, property damage, loss of use or loss of profits. Pleasurecraft Marine Engine Company's policy is one continued improvement of its products and reserves the right to improve and change its design and production of any of its products without assuming any obligation to modify products previously manufactured and/or sold.

No distributor, dealer, agent or employee of Pleasurecraft Marine Engine Co. is authorized to grant any other or further warranty or incur any additional warranty obligation on Pleasurecraft Marine Engine Co.'s behalf, in connection with the sale of its products. There are no warranties which extend beyond those printed herein. Except that any qualification or restriction contained herein which is prohibited by any law where the product is sold is changed to conform with that law making that qualification and/or restriction only null and void. All other qualifications and/or restrictions of this warranty remain in full force and effect.

# GENERAL INFORMATION

**IMPORTANT:** read this manual carefully and thoroughly, particularly **WARNING**, **CAUTION** and **IMPORTANT** information in bold type, such as this paragraph.

**WARNING:** It is recommended that the battery cables be removed from the battery when the boat is placed in storage, on display or in transit. This will eliminate the possibility of the engine accidentally starting and causing damage to the engine due to lack-of water.

Installation of the propeller shaft and associated mounting parts is not outlined in this manual. The propeller shaft angle and propeller location must be determined by the boat builder to meet the requirements of the boat design.

Propeller shaft diameter should be of sufficient size for the type of application. The following propeller shaft couplings are available from PMC.

Shaft Size	Part No. For 1:1, 1.51 and 2:1 Transmissions	Part No. For 2.5:1 and 3:1 Transmissions
1" (25.4mm)	R148010	R 148001
1-1/8" (28.6mm)	R148011	R 148002
1-1/4" (31.8mm)	R148012	R148003
1-3/8" (34.9mm)	R148013	R 148004
1-1/2" (38.1 mm)	R148018	R148005
1-3/4" (44.5mm)		R148007
2" (50.8mm)		R148008
2-1/2"		R148009

The engine drawings should be used when determining engine space requirements and engine bed location. The horizontal angle of the installed engine at rest must be between 0° to 15°.

**#1. CAUTION:** Some engines use a different dipstick for 0° installation than a 15° installation. Be certain that the proper dipstick is installed to prevent damage due to overfilling or underfilling of the crankcase. If in doubt contact your dealer or PCM.

## Engine and Transmission Identification

The engine model and serial number are located on the intake manifold at the rear.

The transmission model, serial number and ratio is located on the transmission case.

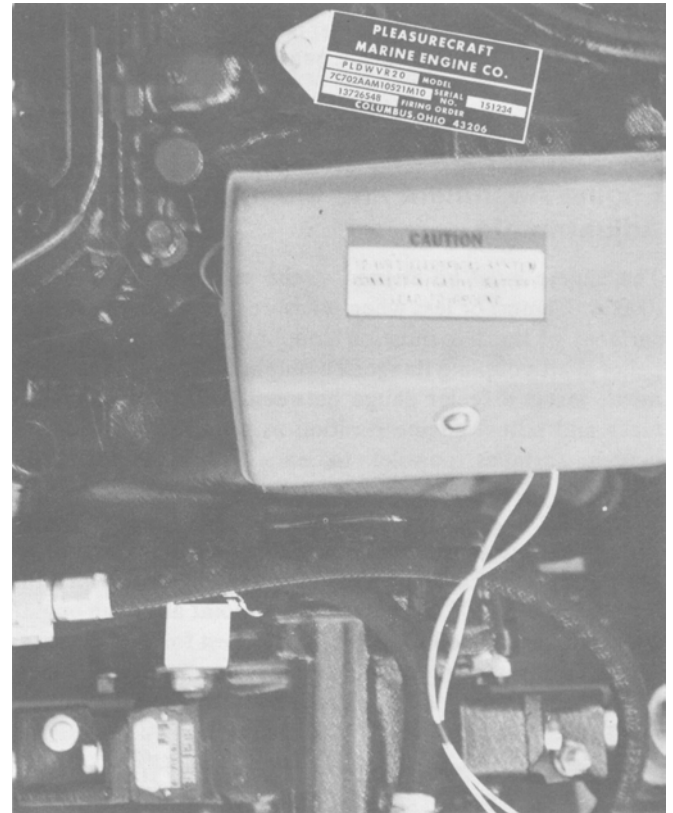

Except for V drives on some applications the propeller shaft rotation -with the transmission in forward gear on engines equipped with 1:1, 1.5:1, 2.5:1 and 3:1 transmissions - is the same as engine rotation.

Propeller shaft rotation - with the transmission in forward gear on engines equipped with 1.9:1 transmissions - is the opposite of engine rotation.

On V drive engines both engines may turn the same direction and have the propeller rotation changed in the V Drive.

On all engines the Serial # plate indicates both engine and propeller shaft rotation. Example: PLD-WV-R20 and PLD-WV-L20. The L following the P indicates the engine rotation. The R and L following the V and preceding the 20 indicates the Propeller Shaft Rotation. The engines must be installed accordingly to insure proper propeller rotation.



**CAUTION: The Warner Gear shift lever MUST BE IN FORWARD; that is, positioned over the letter "F" which is embossed in the case casting for FORWARD gear. Likewise, the shift lever must be positioned over the letter "R" for REVERSE gear on all gear models.**

### Engine Alignment and Mounting Adjustments

The engine must be aligned to the propeller shaft within .003' (.076mm) or less when measured between the mating surfaces of the transmission coupling flange and the propeller shaft coupling flange. To obtain correct engine alignment, insert a feeler gauge between the coupling mating faces and adjust engine position as required to place the mating surfaces parallel to each other within .003' (.076mm).

This clearance must be maintained at all times and at all positions of the coupling. To complete alignment turn the shaft coupling 180° from the starting point after the engine and shaft are aligned to within .003'. Test for proper clearance. If out readjust the engine to proper clearance. Retest by turning coupling 90° at a time and testing to insure alignment at all points through the 360° circle.

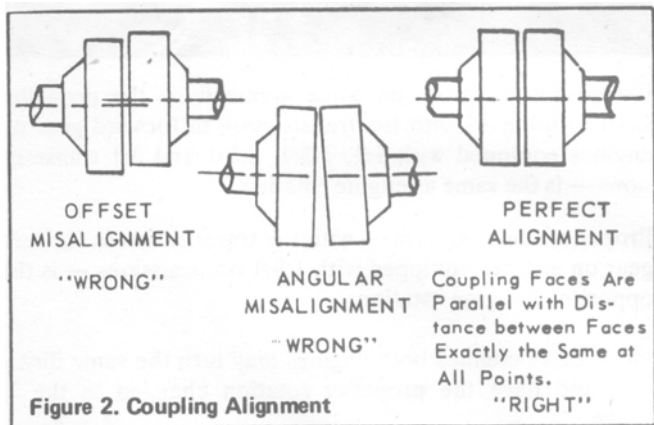

The engine mounts are adjustable to permit raising or lowering the engine and also moving the engine to the right or left. It is recommended that, when the engine bed is installed in the boat, it is positioned so that engine alignment is as close as possible. After engine mounts have been fastened to the engine bed, final alignment should be done by adjusting the mounts as follows:

Front mounts are adjusted by loosening the upper lock nut on the mount stud and trunion locking stud nuts and tapping on the nuts to loosen the studs on the trunion. The mount can then be raised or lowered by screwing the lower nut up or down in the desired direction and side to side by prying against the block. CAUTION: Side to side adjustment must be limited to a maximum 1-3/4" extension of the trunion from the mount bracket. Extension of more can cause bending of the trunion or possible mount failure.

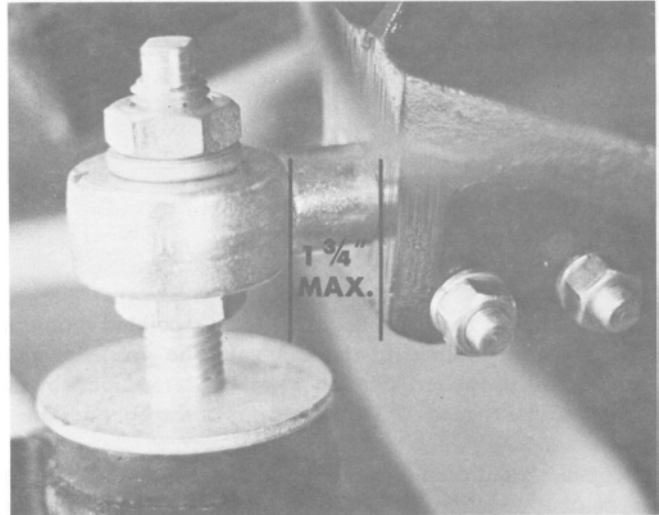

Rear mount adjustment is made by loosening the stud lock nut and turning the stud in the proper direction for vertical adjustment and by loosening and tapping the nut on the lock studs to free the rear trunions and adjust in the same manner as the front for side to side adjustment. CAUTION: Be certain to lock the lock nuts on the adjusting and lock studs when adjustment is completed.

After alignment is complete lag and/or cross bolt mounts securely to the stringers.

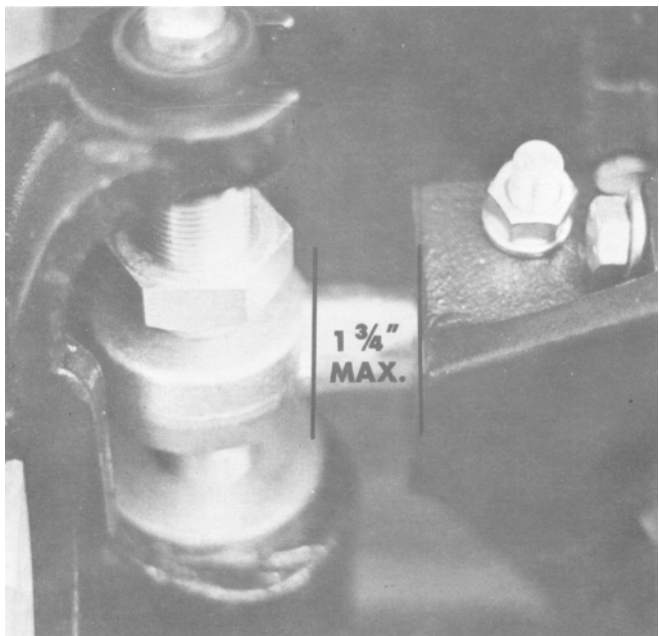

## Water Pick-Up Installation

Water pickup must be large enough to permit sufficient water flow to engine seawater pump in order to provide adequate engine cooling. Pleasurecraft Marine recommends that a sea strainer be installed on all boats equipped with transom or thru-hull water pickups to prevent foreign material from entering and clogging engine cooling systems. Engine damage that results from a clogged cooling system, will not be covered by Pleasurecraft's Warranty.

In the interest of safety, it is recommended that a sea cock be installed between water pickup and sea strainer.

Water pickup should be located as close to seawater pump inlet as possible and in an area where an uninterrupted, solid stream of water will flow past it when boat is underway. Seawater pump inlet is designed for 1" I.D. hose. Hose must have adequate wall thickness to prevent collapsing caused by pump suction. Hose should be fastened securely at connections with hose clamps.

## EXHAUST SYSTEM

When designing the exhaust system, it is very important that the following points are taken into consideration:

1. System must not cause an excessive amount of back pressure. Back pressure must not exceed 4" (10.2cm) of mercury when measured with a mercury manometer at the exhaust manifold outlets. Minimum exhaust hose sizes are as follows:  
Dual Exhaust - 3" I.D. (7.6cm)  
Single Exhaust - 3-1/2" I.D. (8.9cm)
2. System layout and construction must prevent cooling system discharge water from flowing back into the engine and also prevent sea water from entering the engine via the exhaust system.

### Exhaust Hose Installation

The exhaust hose, which connects to the exhaust manifold riser should be connected so that it does not restrict the flow of discharge water from the elbow.

Both exhaust manifolds are water-cooled, and all cooling system water is discharged thru openings which are located inside the risers. To prevent discharge water from flowing back into the engine, the exhaust piping must not be higher than the manifold outlet at any point.

It is the obligation of the boat manufacturer or installing dealer to correctly locate the engine for installation. Therefore, if water is present in the exhaust manifolds or combustion chambers of the engine, the product has not caused the problem, unless there is a defective part.

Hoses, which are connected in a manner to bend in front of the exhaust outlet, will prevent discharge water from flowing around the entire inside diameter of the hose and will cause a hot spot that may burn through the hose.

The exhaust system should have no sags or low spots to accumulate water. Sharp bends of more than 45 degrees in the exhaust lines should be avoided. The exhaust lines should slope toward the transom at a rate of at least 1/2 in. per foot with vessel at rest. Exhaust pipe size should not be restricted. Exhaust back pressure will create poor performance, high fuel consumption, and severe engine damage.

Exhaust transom flanges should be above the water line, and the exhaust lines should be self-draining.

The system should be periodically inspected for leaks and general condition to prevent leakage of water and exhaust gases into the hull. Flapper valves are suggested to be used on all exhaust systems.

## Fuel System Installation

Coast Guard Regulations must be observed when installing fuel system. Fuel systems should be installed in accordance with the standards of industry associations and applicable federal standards.

### Engine Compartment Air Intake

The engine compartment must be properly vented to provide a sufficient amount of air for engine breathing. Air intake and exhaust openings must be large enough to provide an unrestricted volume of air under all operating conditions.

Engine compartment ventilation also should conform to Coast Guard Regulations.

### Control Cable Adjustments

After installation of controls and cables proceed with the following adjustments.

#### Shift Cable

1. Set control lever in neutral position.
2. Position shift selector on the warner gear into neutral position. In moving the selector from neutral to forward to reverse to neutral three distinct detent positions will be felt.
3. Adjust the connector on the control cable so the connector slips freely into the hole in the selector arm.
4. Remove the connector from the selector arm and move the selector and control lever into the forward position. In this position the shift lever must cover the "F" cast into the transmission case. The connector should slip freely into the hole in the selector arm.

- Repeat step #4 with the selector and control levers in reverse position.

If the movement of the connector does not correspond with the movement of the selector lever it will be necessary to readjust the remote control head to provide the proper direction of control cable travel.

**CAUTION: Transmissions operated in reverse to propel the boat forward will fail early. Engine and propeller rotation must be matched according to the Serial Plate.**

### Throttle Cable

- Place control lever on single lever control into forward gear without advancing the throttle and on a twin lever control in the fully closed position.
- Adjust the connector so that it slips freely into the connector socket and lock into place.
- Position throttle into the full throttle position after blocking the choke open. Check to see if the throttle valves are in the full open position on both the primary and secondary side if so equipped.

If valves do not open fully make necessary adjustments at either control head or cable connector to insure full opening. Repeat steps #1 and 2 to insure proper idle settings and adjust if necessary.

### Battery Specifications

Battery Specifications Must Be as Follows:

12 volt marine type  
Tapered post connectors  
70 amp-hr. minimum rating

### Battery Cable Size Specifications

Cable Length	Cable Size Required
Up to 3 Ft. 6 In.	#4 Gauge
3 Ft. 6 In. to 6 Ft.	#2 Gauge
6 Ft. to 7 Ft. 6 In.	#1 Gauge
7 Ft. 6 In. to 9 Ft. 6 In.	#0 Gauge
9 Ft. 6 In. to 12 Ft.	#00 Gauge
12 Ft. to 15 Ft.	1 #000 Gauge
15 Ft. to 19 Ft.	2 #0000 Gauge

1 In. (1 n c h) = 2.54cm 1 Ft. (Foot) = 30.5cm

NOTE: Cable sizes apply both to positive (+) and negative (-) cables. Terminals must be soldered to cable ends to provide adequate contact.

### Battery and Battery Cable Installation

- Battery should be positioned as close to engine as possible and should be securely mounted in boat.
- Connect negative (-) battery cable to ground on engine, connect positive (+) battery cable to solenoid.
- Connect positive battery cable to positive post on battery and negative battery cable to negative (-) post on battery.

**IMPORTANT:** Engine electrical system is negative ground. Failure to connect battery leads, as outlined, will damage system.

#### MISCELLANEOUS INSTALLATION INSTRUCTIONS

**WARNING: Before starting engine always ventilate engine compartment by opening engine hatch or, if equipped, operate bilge blower a sufficient amount of time to remove any gas fumes from engine compartment. It is doubly important to check for fuel spillage or leaks after repair, refueling or maintenance before starting engine. Remove battery cable from battery before attempting any maintenance, repairs or when boat is placed in storage or in transit.**

### Check Before Running

- Engine oil level.
- Transmission lubricant level.
- Engine drain plugs installed.
- Leakage (fuel and water lines and connections).
- Throttle shutters full close at idle (neutral).

### Check While Running (See "Caution", Below)

- Oil pressure 35 to 40 PSI (2.5 to 2.8kg/cm<sup>2</sup>) (Approx.) at 2000 RPM.
- Water temperature 140°-160° R/W and 180°-200° F/W
- Idle RPM (550-600) in gear
- Maximum forward RPM 4,400
- Shifting linkage (forward, neutral and reverse) for shift lever in detent and proper direction.
- Leakage (water, oil and fuel)

### Check After Initial Run

- Engine alignment
- Engine mounting fasteners are tight.
- Engine oil level
- Transmission oil level and shift connections.

**CAUTION: Do Not Operate Engine without Cooling Water Flowing thru Water Pump, or Neoprene Water Pump Impeller Will Become Damaged. Attach Water Hose to Pump Inlet. Run Engine Slowly (650-700 RMP) in Neutral to Circulate Water. Watch Water Temperature Gauge to Prevent Overheating.**

## Operating Limits (See Specifications for Your Model)

Maximum RPM at wide open throttle under normal load conditions can be controlled only by propeller pitch, diameter, and design. It is essential that the propeller selected does not overload or underload the engine. Extreme overloading resulting in low RPM's at wide open throttle will deliver poor performance, poor fuel economy, and eventually result in engine damage. Underloading will result in high RPM, poor fuel economy, and engine damage, if operated above recommended maximum RPM's.

Do not operate at high RPM's in neutral. Operation in extremely shallow water can cause sand, silt, and gravel to be pulled into the cooling system. This can create excessive water pump wear, and in extreme cases may deposit in the engine block water jackets and seriously damage the engine from improper cooling. Heavy weed growth can plug oil coolers and water intakes and cause damage. If operation under these conditions is necessary, a good quality sea water strainer or filter should be installed. The installation of a fresh water cooling system can reduce the danger of engine damage from this cause.

ALWAYS OBSERVE HIGH SAFETY STANDARDS AND COURTESY AFLOAT.

## Propellers

Propellers can affect the performance of your boat in many ways. Selection of the proper propeller for your application is vital. In most cases, the selection is made by the Boatbuilder for best over-all performance; however, many variable factors, such as heavy loads, high altitude, hull balance, etc., can contribute toward rendering the "standard" propeller unsuitable, since the application is no longer "standard."

Many undesirable results can occur from a propeller not properly matched to the specific application; high RPM's, low RPM's, cavitation, vibration, steering torque (stem drives), drumming or rumbling noise, high fuel consumption, poor efficiency, and even electrolysis damage (stem drive). When changing propellers, extreme care should be taken to select a propeller which allows the maximum engine RPM's with normal load to be within the proper range for the particular model. See the engine specification chart in this book for "Maximum RPM."

The use of brass or bronze propellers on stern drives in salt water or water with high mineral or acid content is not recommended, due to the possibility of electrolytic attack and corrosion of the outdrive housings.

If the propeller is bent, broken, out of balance, or otherwise damaged, limit operation to bare necessity until the propeller is repaired or replaced.

## Directional References

Directional references are given as they appear when viewing boat from stern, looking toward bow. Front of boat is bow; rear is stern. Starboard side is right side; port side is left side.

## Service Recommendations

This manual includes operating and maintenance instructions that are usually required in normal service. Do not attempt any repairs which are not specifically covered in this manual. Strict compliance to the recommendations for lubrication, maintenance, operation, etc., will assure you of superior performance and dependable service.

## Literature

To obtain service and/or parts literature for your PCM Engine(s) contact your dealer or write:

PCM  
P.O. Box 130  
Canal Winchester, Ohio 43110

## Serial Number Locations

Serial number of your PCM Engine is located at rear of engine on the Intake Manifold. Transmission serial number is located on the transmission case.

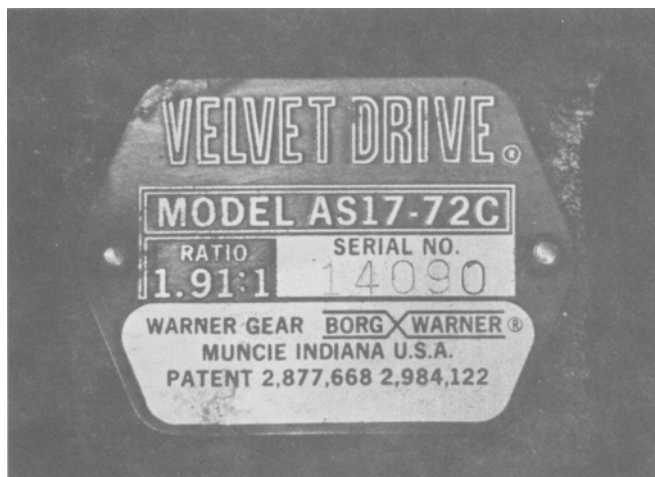
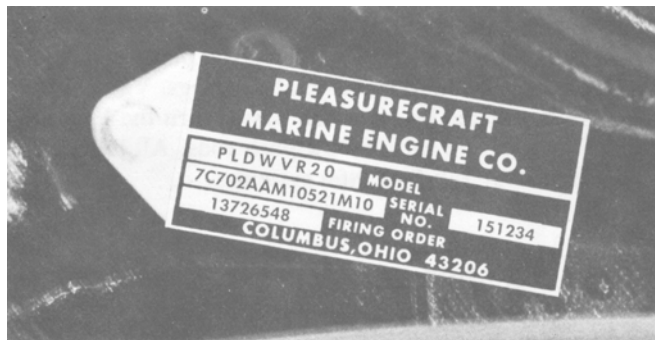

## Service Information Request

When contacting the factory, include the following information:

1. Engine and transmission serial and model numbers.
2. Date purchased.
3. Name of selling dealer.
4. Boat manufacturer, model and length.
5. Number of hours unit has been operated.
6. Date of previous correspondence.

For your convenience there is a form which can be used when writing PCM.

Record These Numbers from the Serial Number Plates on the engine and transmission.

	Port	Starboard
Engine Model		
Engine Serial No		
Transmission Model		
Transmission Serial No.		

## Marine Engine Description

PCM engines are 4-cycle, overhead valve, V-8 engines. Lubrication is provided by a rotor-type oil pump which provides full pressure lubrication to all bearings. Valve rocker arms are lubricated by oil which passes thru the hydraulic valve lifters and up thru hollow push rods. All lubricating oil is filtered by a full-flow filter system.

## PCM Installation and Delivery Inspection

The selling dealer must check the items listed below prior to delivery of your PCM Engine. Check with him to be sure that these checks have been completed.

Check and Adjust as Necessary

1. Engine oil level and transmission oil level
2. Battery condition
3. All mounting bolts
4. Engine Alignment

Start Engine and, While Running, Check

**CAUTION: DO NOT operate engine without cooling water flowing through water pump, or water pump will be damaged, and subsequent engine damage may result.**

(With Engine Warmed-Up at Fast Idle to Normal Operating Temperature)

1. Oil pressure and cooling water flow
2. Ammeter or voltmeter function
3. Exhaust, oil and fuel system for leaks
4. Idling speed (adjust as necessary)
5. Operation of throttle and shift controls

Test Run Boat and Check (in water)

1. Recommended engine RPM (as stated under "Specifications")
2. Operation of throttle and shift controls
3. General operation of craft

## MAINTENANCE AND TUNE-UP

### Fuel Requirements

Use any good grade automotive regular or premium gasoline with a minimum average octane rating of 88\* (93 research) in your PCM engine.

An 86\* average octane (90 research) gasoline may be used if the gasoline described above is not available; however, the ignition timing MUST BE retarded 41 to prevent harmful detonation.

\*New U.S. Regulation requires posting average of research and motor octane.

PCM reserves the right to refuse warranty on parts which are damaged -when using improper gasolines.

### Replacing Fuel Filter

PCM recommends the use of a Remote Mounted fuel filter and/or water separator and fuel filter on all its engines. Fuel filters are not standard with PCM engines, however, we do offer them as an option to all Boat Builders and Dealers. If your Boat is not equipped with a fuel filter see your PCM Dealer. He can provide you with the proper parts and installation service to protect your engine's fuel system. When replacing the fuel filter element, follow the manufacturer's instructions and the following cautions.

**CAUTION: Be careful of spilled fuel. Gas vapor buildup is explosive.**

NOTE: DO NOT re-use; always replace with new filter and gasket.

**CAUTION: DO NOT operate engine without cooling water flowing thru water pump, or water pump impeller will be damaged, and subsequent engine damage may result.**



- 1 - Oil Filler Cap
- 2 - Dipstick (May Be Located on Right Side)
- 3 - Water Pickup Pump
- 4 - Sight Tube
- 5 - Fuel Pump
- 6 - Coil
- 7 - Thermostat Housing
- 8 - Distributor
- 9 - Flame Arrestor
- 10 - Alternator
- 11 - Front Mounts
- 12 - Rear Mounts
- 13 - Alternator Drive Belt
- 14 - Water Pickup Pump Drive Belt
- 15 - Oil Filter
- 16 - Transmission Oil Cooler
- 17 - Block Drain
- 18 - Lifting Eye
- 19 - Starter

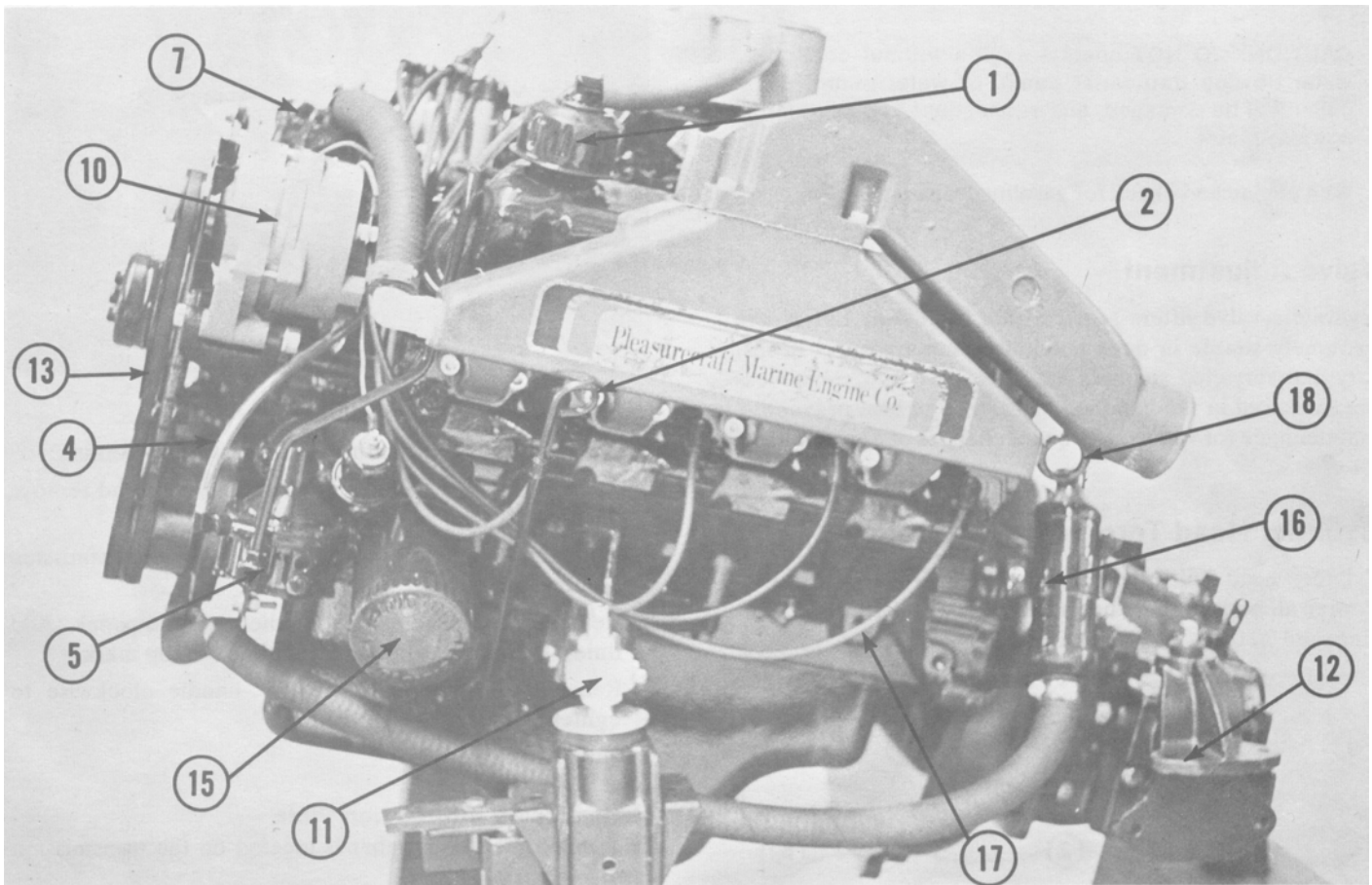
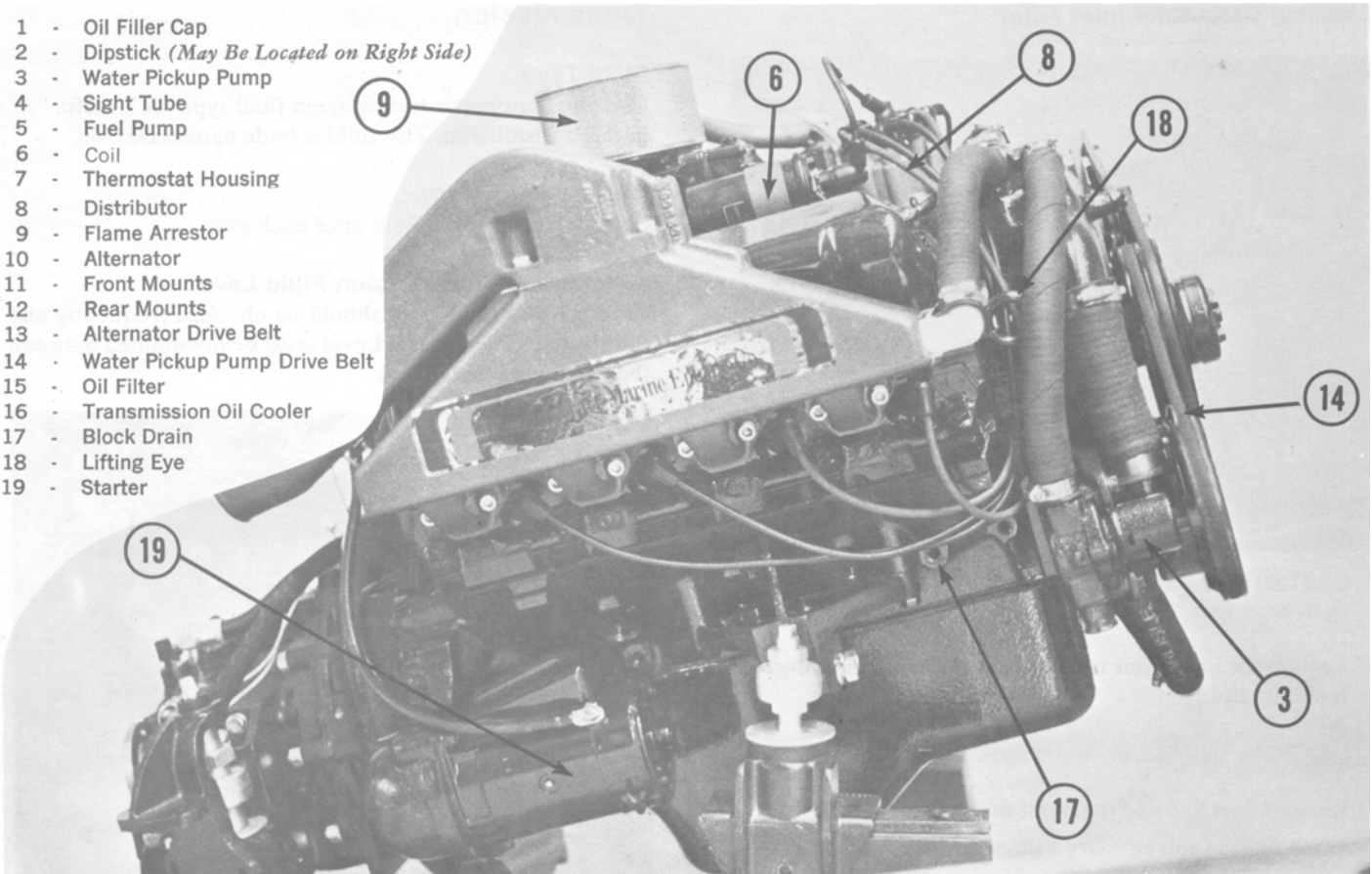

## Cleaning Carburetor Inlet Filter

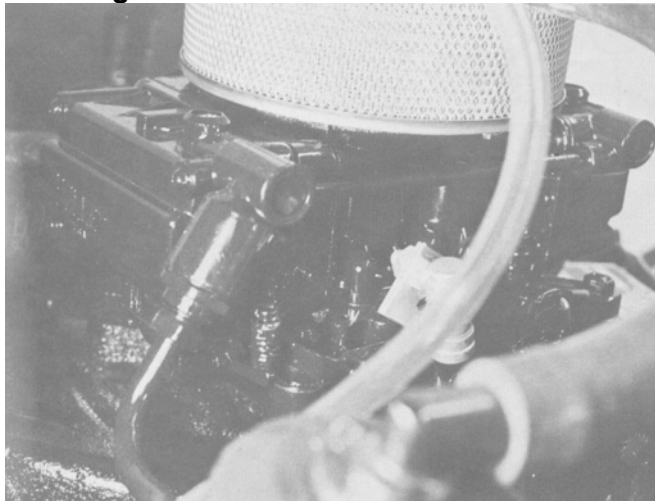

**CAUTION: Be careful of spilled fuel. Gas vapor buildup is explosive.**

1. Carburetor inlet filter is located in primary float bowl in fuel inlet fitting.

**CAUTION: Use care so fuel is not spilled.**

2. Remove fuel line and fuel inlet fitting from carburetor.
3. Wash filter in solvent. Dry with compressed air.
4. Install new gasket on fuel inlet fitting. Install fitting into carburetor and tighten. Install fuel line.

**CAUTION: DO NOT operate engine without cooling water flowing thru water pump, or water pump impeller will be damaged, and subsequent engine damage may result.**

5. Run engine and check for gasoline leaks.

## Valve Adjustment

Hydraulic valve lifters require little attention. Lifters are extremely simple in design, readjustments are not necessary and servicing requires only that care and cleanliness are exercised in the handling of parts. The best preventive maintenance for valves is frequent changes of engine oil.

## Cylinder Head Torque and Sequence

Cylinder head bolts are tightened in 3 progressive steps. Torque all bolts in sequence and finally to 100 ft. on 351 engines and 70 ft. lb. on 302 engines.

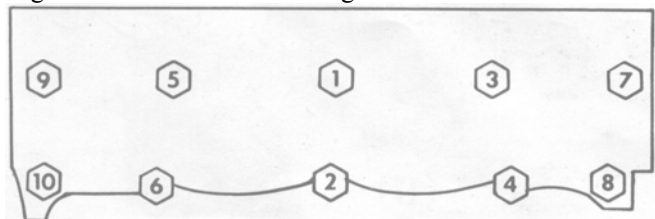

## Transmission

### Fluid Type

Use only automatic transmission fluid type "A", suffix "A" in this transmission. This fluid is trade named Dexron.

### Change Frequency

Change transmission fluid once each year.

### Maintaining Transmission Fluid Level

Transmission fluid level should be checked frequently and fluid added if necessary. Level must be maintained between the two marks on dipstick.

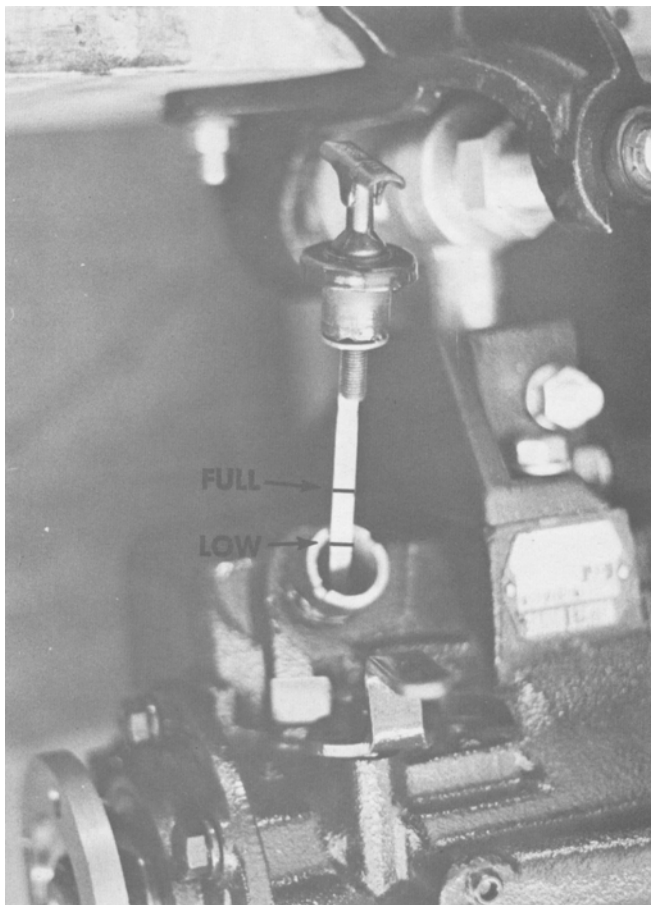

### Maintain fluid level as follows:

1. Boat must be at rest in the water and engine running.
2. Turn dipstick "T" handle counterclockwise and remove dipstick.
3. Wipe fluid off dipstick and set in position in transmission fill hole.
4. Remove plug and note level indicated on dipstick. Add fluid, if required, to bring level up to the top mark.
5. Reinstall dipstick and turn "T" handle clockwise to tighten.
6. Shut off engine.

### Transmission Information Plate

Transmission serial number is located on the transmission case.

# SPECIFICATIONS SECTION

Model	351/4	302/2, 302/4
Bore	4.00"	4.00"
Stroke	3.50"	3.00"
Cubic Displacement	351 cubic inches	302 cubic inches
Horsepower	240@4400 RPM	175@4400 302 2/V 220@4400 302 4/V
Intermittent Service	4400	4400
Continuous Cruise	3600	3600
<b>NOTE: Do not cruise at high limits of above range unless propped to turn at or near maximum RPM's at full throttle.</b>		
Idle Speed, in forward gear	600 RPM	600 RPM
Timing	10 degrees BTC @ 600 RPM	10 degrees BTC @ 600 RPM or lower
Breaker Point Gap	.018"	.018"
Breaker Point Dwell	24 to 29 degrees	24 to 29 degrees
Spark Plug Gap	.035	.035
Spark Plug Type*	Motorcraft BTF3M or Autolite 124 or Champion F10. 18MM Motorcraft ARF32M or Autolite 24 or Champion RBL11Y. 14MM	Motorcraft BTF3M or Autolite 124 or Champion F10. 18MM Motorcraft ARF32M or Autolite 24 or Champion RBL11Y. 14MM
<i>*These numbers have been corrected when copied from original document</i>		
Firing Order	See engine identification tag*	See engine identification tag*
Recommended Fuel	Regular grade, leaded 93 octane minimum (Research method)	Regular grade, leaded 93 octane minimum (Research method)
<b>NOTE: Low lead fuel of proper octane rating may be used intermittently. Unleaded fuel should not be used.</b>		
Recommended Oil – See Engine Lubrication Section for further information.		
Engine	10W30 or 10W40 premium grade	10W30 or 10W40 premium grade
Warner Drives and Vee Drives	Automotive Transmission Fluid (ATF), Type A, Suffix A. Dexron	Automotive Transmission Fluid (ATF), Type A, Suffix A. Dexron
Carburetor	Holley 4 bbl	175 – 2 bbl Holley 220 – 4 bbl Holley
Fuel Pump	Marine approved, double diaphragm, with safety sight tube	Marine approved, double diaphragm, with safety sight tube
Electrical System	12 Volt, Negative ground	12 Volt, Negative ground
<b>WARNING: DO NOT reverse battery cables on battery terminals. DO NOT spark battery cables against terminals to check polarity. Damage to charging system components may result if these precautions are not observed.</b>		
Alternator	Marine approved, 35 AMP.	Marine approved, 35 AMP.
Regulator	Sealed solid state transistorized	Sealed solid state transistorized
Battery Recommended	Marine type of 70 AMP. hr. minimum	Marine type of 70 AMP. hr. minimum
Oil Capacity	4 quarts and 1 for filter	4 quarts and 1 for filter

**\* L.H. Rotation**  
Firing Order  
1-3-7-2-6-5-4-8 LC & LD  
1-5-4-2-6-3-7-8 LE

**R.H. Rotation**  
Firing Order  
1-8-4-5-6-2-7-3 RC & RD  
1-8-7-3-6-2-4-5 RE

# Models – *INBOARD*

351/4

302/4

302/2

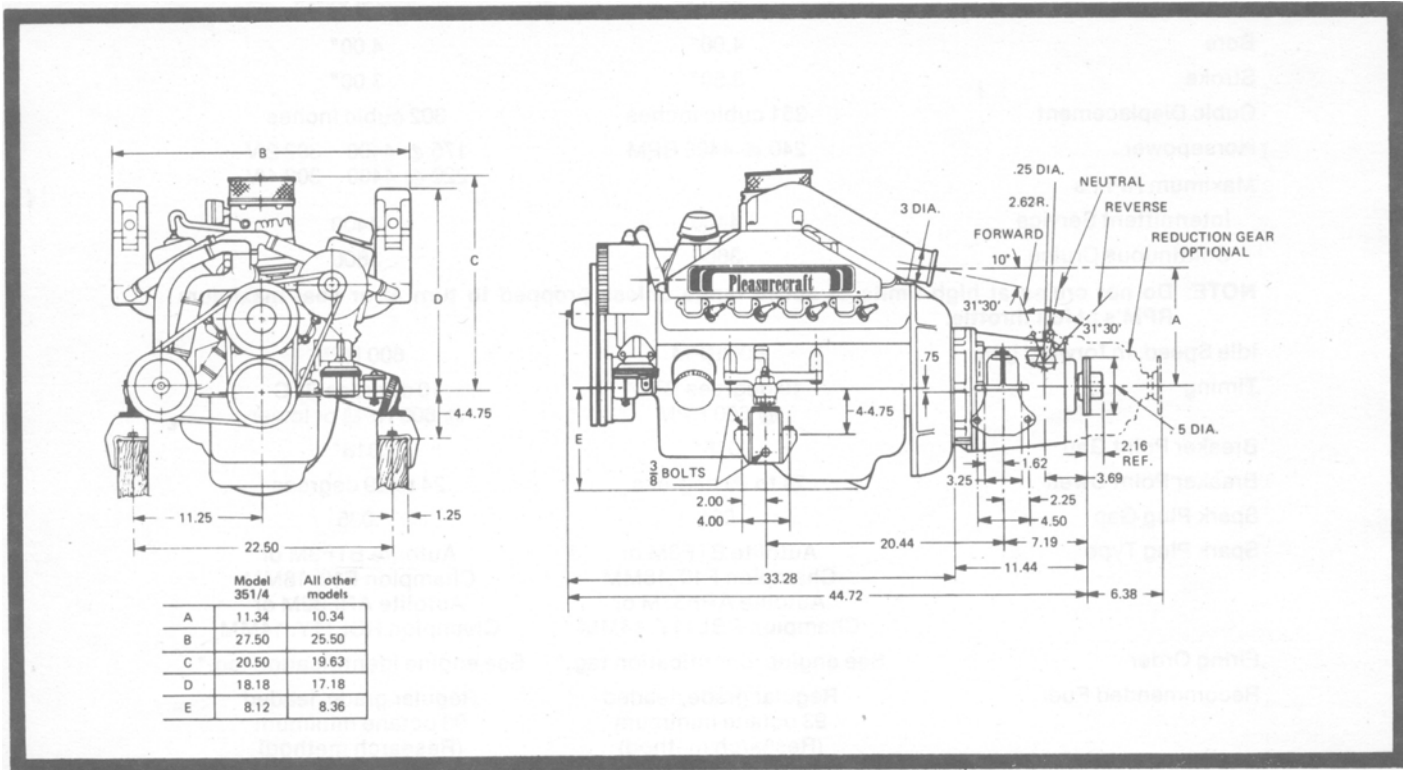

# Models – *VEE DRIVE*

351/4

302/4

302/2

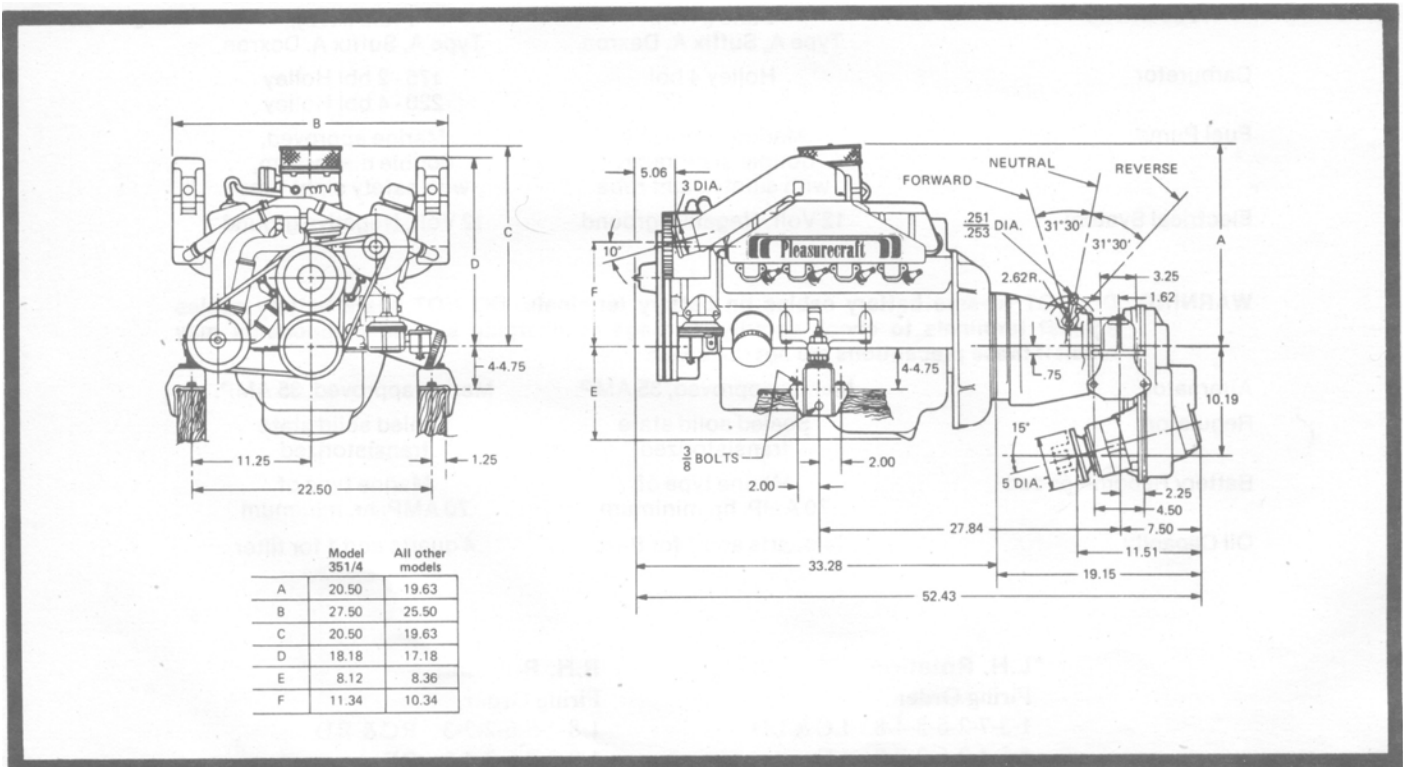

## Maintenance Chart

	Weekly	After 1 <sup>st</sup> 25 Hrs of Operation (1)	Every 50 Hours of Operation (1)	Every 100 Hours of Operation (1)	Once Each Year (1)
Change Engine Oil		•			
Replace Oil Filter		•			
Clean Oil Filler Cap				•	
Check Transmission Fluid Level	•	•	•		
Change Transmission Fluid					•
Check Sea Water Strainer					
Clean Flame Arrestor		•		•	
Clean Crankcase Ventilating System		•		•	
Check Water Pump and Alternator Belts for Tension	•	•	•		
Change Fuel Filter					•
Check Fuel System Lines and Connections for Leaks	•	•	•		
Clean Carburetor Fuel Inlet Filter		•		•	
Clean Transmission Oil Strainer Screen					•
Lubricate Distributor Cam					•
Inspect Breaker Points				•	
Check Condition of Spark Plugs					•
Check Battery Electrolyte Level	•	•	•		
Check All Electrical Connections		•			•
Check Cooling System Hoses and Connections for Leaks	•	•		•	
Tighten Engine Mount Fasteners					•
Lubricate Throttle and Shift Linkage Pivot Points					•
Check for Loose, Damaged or Missing Parts	•		•		
Check Engine to Propeller Shaft Alignment		•			•

The inspection and maintenance schedule, above, is based on average operating conditions in utility service. Under severe operating conditions, intervals should be shortened.

(1) Refer to Viscosity Chart.

(2) If engine overheats. Visually check. If clogged, clean out.

## CYLINDER NUMBERING LOCATION GUIDE

L. H. ROTATION  
FRONT

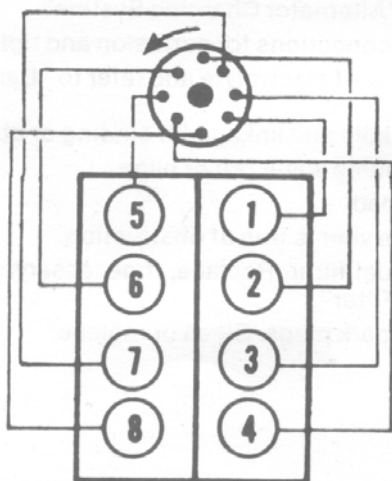

FIRING ORDER  
1-5-4-2-6-3-7-8

L. H. ROTATION  
FRONT

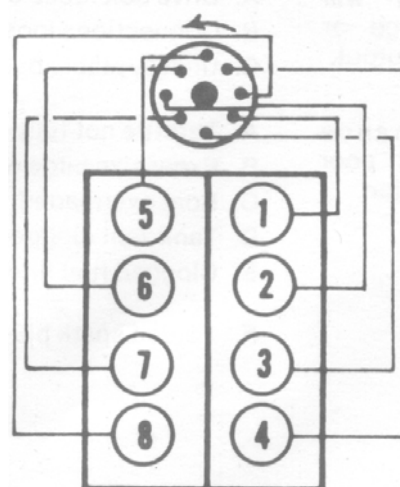

FIRING ORDER  
1-8-7-3-6-2-4-5

# ENGINE TROUBLESHOOTING

**IMPORTANT:** The following chart is a guide to aid you to find and correct minor engine malfunctions. If the problem has not been corrected after following the guide, **DO NOT** attempt further repairs. See your authorized P.C.M. Dealer

**WARNING:** Before attempting any checks or repairs, battery cable **MUST BE REMOVED** from battery to prevent possible personal injury or damage to equipment.

Trouble	Cause	What You Can Do About It
1. Starter won't turn engine.	A. Control lever. B. Loose or corroded battery connections. C. Weak battery.	Make sure control lever is exactly in neutral. Tighten cables on battery. If corroded, clean as described under "Battery Maintenance". Check level of electrolyte and refer to "Battery Maintenance".
2. Engine won't start or is hard to start.	A. Empty fuel tank. B. Tank vent clogged. C. Shut-off valve closed. D. Clogged fuel filter.  E. Choke not operating properly. F. Engine flooded. G. Fouled spark plugs or improper gap. H. Cracked or dirty distributor cap or rotor. I. Poor connections or damaged ignition wiring	Check fuel supply. Make sure vent is free of obstruction. Check valve to make sure it is open. Inspect fuel filter. Replace, if necessary, as outlined under "Replacing Fuel Filter". Inspect carburetor choke linkage for any binding or obstructions. Do not attempt to start engine for at least 5 minutes. Inspect spark plugs. Clean or replace. Inspect contacts and surfaces. Clean or replace.  Check wires for wear or breaks and tighten all loose connections.
3. Poor idling or engine misses while idling.	A. Choke not operating properly. B. Corroded wire ends or distributor cap towers. C. Fouled spark plugs or improper gap. D. Weak battery. E. Cracked or dirty distributor cap or rotor. F. Loose spark plug wires.	Inspect carburetor choke linkage for any binding or obstructions. Check wires and towers for corrosion. Clean or replace.  Inspect spark plugs. Clean or replace. Check level of electrolyte and refer to "Battery Maintenance". Inspect contacts and surfaces. Clean or replace.  Check both ends of each wire to ensure good contact to plug and distributor cap.
4. Engine misses on acceleration or at high speed (loss of power).	A. Fouled spark plugs or improper gap. B. Cracked or dirty distributor cap or rotor. C. Poor connections or damaged ignition wiring.	Inspect spark plugs. Clean or replace. Inspect contacts and surfaces. Clean or replace.  Check wires for wear or breaks and tighten all loose connections.
5. Oil pressure drop.	A. Low oil level. B. Clogged oil filter.	Refer to "Maintaining Engine Oil Level". Refer to "Draining Engine Oil and Replacing Oil Filter".
6. Engine backfires.	A. Spark plug leads installed wrong.	Make sure correct lead is installed on proper plug and proper tower on distributor cap.
7. Alternator will not charge or has low output	A. Drive belt loose or broken. B. Connections loose or dirty. C. Unacceptable battery condition.	Refer to "Alternator Charging System". Inspect connections for corrosion and tighten all loose connections. Check level of electrolyte and refer to "Battery Maintenance".
8. Performance loss and poor acceleration.	A. Throttle not fully open. B. Excessive bilge water. C. Boat overloaded. D. Tank vent clogged. E. Clogged fuel filter.  F. Fouled spark plugs or improper gap.	Inspect cable and linkage for binding or obstruction. Drain or pump water out of bilge. Reduce load. Make sure vent is free of obstruction. Inspect fuel filter. Replace, if necessary, as outlined under "Replacing Fuel Filter". Inspect spark plugs. Clean or replace.

# ENGINE LUBRICATION

## Selecting Crankcase Oil and Change Intervals

Crankcase oil should be selected to give best performance under the climatic and operating conditions prevalent in the area in which the engine is operated. An oil, which will provide adequate lubrication under high operating temperatures, is required during warm or hot weather. An oil, which will permit easy starting at the lowest atmospheric temperature likely to be encountered, should be used during colder months. When crankcase is drained and refilled, crankcase oil should be selected on the basis of prevailing temperature for period during which oil is to be used.

We recommend 10W30 or 20W40 or any good grade automotive oil of correct viscosity which has an A.P.I. classification of "SE".

The following chart shows the recommended viscosity for various temperature ranges and also the intervals at which the oil should be changed.

After 25-Hour Break-In Period

Prevailing Daytime Temperature	API Classification & Viscosity	Oil & Oil Filter Change Intervals
0°F(-18°C)	SAE 20W "SE"	25 hrs of operation or 30 days whichever occurs first
32°F(0°C)to 90°F(32°C) 90°F (32°C) and Above	SAE 30W "SE" SAE 40W "SE"	50 hrs. of operation or 60 days whichever occurs first

## Engine Crankcase Capacity

The engine crankcase capacity is approximately 5 qts. With new, dry oil filter. Because of the effect the installed angle of the engine has on the oil level, different dipsticks are used on some engines for 0° & 15° Installation angles. Be certain the proper amount of oil is in the crankcase at all times. If any question arises contact your PCM Dealer.

## Oil Filter

A full-flow oil filter filters all of the oil delivered by the oil pump and, for this reason, interval of cartridge change is very important. Oil filter cartridge should be replaced after the first 25 hours and every oil change thereafter and at end of boating season.

## Maintaining Engine Oil Level

It must be emphasized that every internal combustion engine should use a certain amount of oil to act as a lubricating and cooling agent, particularly during the break-in period, and the initial rate of consumption gradually will decrease until it becomes stabilized after approximately 100 hours operation.

The engine oil level should be checked frequently and oil added when necessary.

When checking oil levels, the engine should be warm, the boat must be at rest in the water, the dipstick pushed down to the stop, and sufficient time (approximately 1 minute) must be allowed for oil to drain back from the upper engine cavities to the pan, or a false reading may be obtained.

The space between "Full" and "Add" marks represents one quart, and it is not necessary to add oil unless the level is near the "Add" mark.

Maintaining a proper oil level also is an important factor in controlling oil consumption. An over-full crankcase will allow oil to be splashed by the reciprocating parts onto the cylinder walls in greater quantities than the rings can control. This excess oil, subsequently, will be drawn into the combustion chamber and burned.

On the other hand, when an engine is used principally at slow speed conditions, where considerable crankcase dilution occurs, a rapid lowering of the oil level may result when the boat is operated for some distance at high speed. This is due to the dilution from slow running which is removed from the crankcase by the heat of high speed operation. This is a normal condition and should not be mistaken for excessive oil consumption.

## Alternator

Under normal operating condition, alternator will not require lubrication.

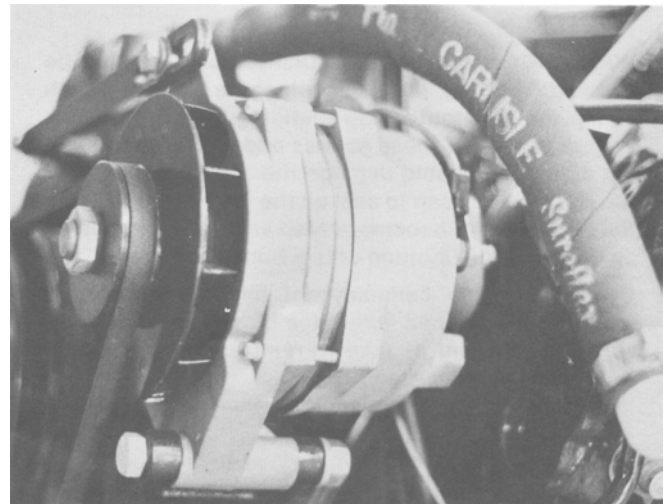

## Starting Motor

Starting motor end frames are equipped with oil-less bearings which do not require lubricant.

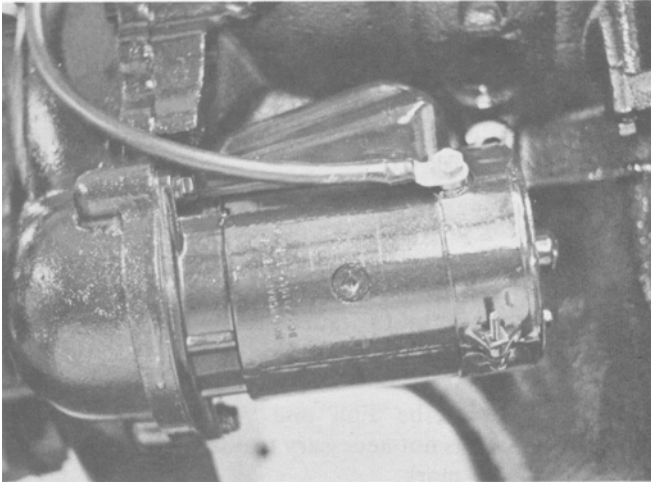

## Distributor Lubrication

Distributor cap should be removed every 100 hours. Apply small amount of Cam and Ball Bearing Lubricant or other suitable high-melting-point, non-bleeding grease on distributor cam surface and on distributors equipped with an oil cup lubricate with engine oil.

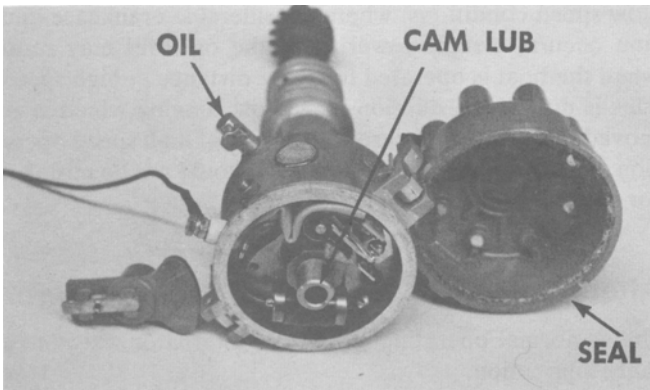

**WARNING:** Removal of the Distributor Cap must be accomplished by first loosening the screws which clamp the Distributor Cap retaining clips into place. Failure to loosen these screws and prying the retaining clips loose could damage the cap and/or destroy the ability of the cap to seal on the distributor causing the distributor to become vented and no longer sealed against possible ignition of fuel fumes if present.

Ventilate engine compartment by opening engine hatch or, if equipped with bilge blower, operate for a sufficient amount of time to remove any gas fumes from engine compartment.

## Starting and Operating

A routine pre-starting procedure should always be carried out before the first startup of the day.

1. Check oil in engine.
2. Inspect sight tube of fuel pump.
3. Check for gasoline fumes in bilges or engine compartment.
4. Operate engine room blower for sufficient time to remove any fumes.
5. Operate bilge pump until bilges are dry.

Other items to be inspected may exist, depending on the nature of the boat. It is advisable to formulate a check list containing all items relative to your boat, and follow it faithfully.

Consult your local Coast Guard Auxiliary or Power Squadron for full details on boating safety.

**NOTE:** Bilge blowers, bilge pumps, and other accessories should not be connected to the ignition terminal or ignition circuit. The engine is equipped with an automatic choke which is opened by an electric heating unit. If the ignition is on for one or two minutes prior to starting, the choke will be open and inoperative, and starting may be extremely difficult.

**BEFORE STARTING, BE SURE THE SHIFT SELECTOR IS IN NEUTRAL.** Models equipped with Warner Velvet Drive transmissions, or Warner Vee Drives, have a factory installed safety switch incorporated, which prevents actuation of the starter unless the shift selector is in neutral. Other models do not. Before starting a cold engine, pump the throttle two or three times from closed to open to closed. Open throttle slightly above the idle position, and actuate starter. As soon as the engine starts, return the throttle toward closed to establish the engine speed at 1200 to 1600 RPM's, and give the engine a short period to warm up and smooth out. When all else is in readiness, reduce speed to idle, shift into gear, and proceed normally.

**IMPORTANT:** Do not continue to operate starter for more than 30 seconds without pausing to allow starter motor to cool off for 2 minutes. This also will allow battery to recover between starting attempts.

**NOTE:** Pumping the throttle should not be necessary with a warm engine. A warm engine should start readily with the throttle closed, by simply actuating the starter.



During the warmup period, scan the instrument panel for correct operation of all systems. Oil pressure should read 35 to 65 lbs. Water temperature should gradually increase to the normal controlled level of 140-160 degrees on direct water cooled models, 180-200 degrees on fresh water cooled models. Alternator charge output should be indicated on the ammeter by the needle indicating toward the (+) side of zero. IF EQUIPPED WITH A VOLTMETER, THE VOLTAGE SHOULD GRADUALLY RISE TO APPROXIMATELY 13.5 VOLTS, AND REMAIN THERE WHILE THE ENGINE IS OPERATING.

## **Break In**

DO NOT OPERATE AT SUSTAINED FULL THROTTLE DURING THE FIRST 5 HOURS OF OPERATION.

DO NOT OPERATE AT HIGH RPM'S IN NEUTRAL.

After the engine is thoroughly warmed up, and the boat is underway, open the throttle wide until full RPM's are reached. DO NOT EXCEED MAXIMUM RPM. (RPM's should cease climbing after 10 to 20 seconds.) Reduce throttle to 2,800 to 3,000 RPM, and cruise at or below the speed for 1/2 hour. Reduce speed to idle, open throttle wide, and operate at that speed for approximately 1 minute; reduce to cruise throttle for a few minutes and repeat. (Bringing the engine from idle speed to full throttle will load the engine and assist in seating the piston rings.) This cycle can be repeated from time to time during the first 5 hours of operation, but full throttle should not be sustained for more than 1 to 2 minutes.

FOLLOW THE PROCEDURE ONLY WHEN CONDITIONS ARE SUCH THAT IT CAN BE DONE IN COMPLETE SAFETY.

DO NOT ATTEMPT TO BREAK IN AN ENGINE BY PROLONGED IDLING OR RUNNING IN AT THE DOCK.

During the early part of the break in period, correct propeller selection can be confirmed. (With a normal load aboard, the engine RPM's should reach, but not exceed, maximum RPM's as listed under specifications for your model.)

During the break in, water temperature should be watched carefully, and speed reduced if overheating becomes evident.

# HOLLEY CARBURETOR

The following description covers a sample Holley Carburetor. The carburetor on your engine may look different from the illustrations but the carburetor functions exactly the same way. Carburetor service demands particular care in cleanliness and precise adjustments. If you are not equipped with the proper knowledge, tools and equipment it is recommended that you have a knowledgeable dealer repair any and all carburetor malfunctions.

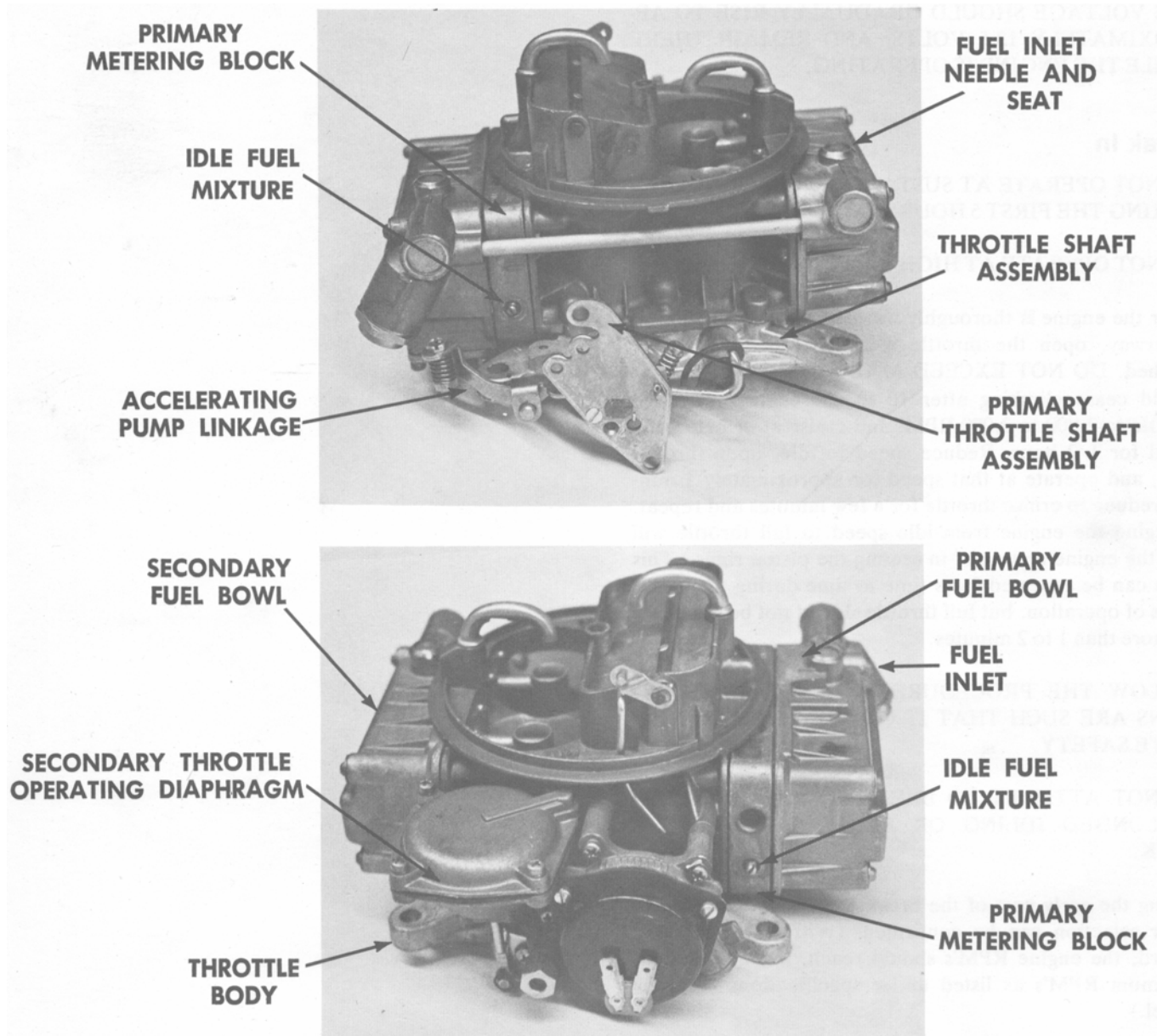

## Description and Operation

The carburetor is a downdraft two-stage carburetor. The carburetor contains a primary power system or power valve located within the primary metering block only.

The primary stage of the carburetor contains a fuel bowl, metering block, and an accelerating pump assembly. The primary barrels each contain a primary and booster venturi, main fuel discharge nozzle, throttle plate, and an idle fuel passage. The choke plate mounted in the air horn above the primary barrels, is automatically controlled by an electric choke mechanism.

The secondary stage of the carburetor contains a fuel bowl, a metering body and the throttle operating diaphragm assembly. The secondary barrels each contain a primary and booster venturi, idle fuel passages, a transfer system a main secondary fuel discharge nozzle, and a throttle plate.

A fuel inlet system for both the primary and the secondary stages of the carburetor provides the fuel metering systems with a constant supply of fuel. In addition, a carburetor automatic choke system provides a means of temporarily enriching the fuel mixture to aid in starting and operating a cold engine.

# CARBURETOR PROBLEM DIAGNOSIS

<b>Flooding or Leaking Carburetor</b>	<p>Cracked carburetor body, or fuel bowl.            Defective main body and/or bowl gasket(s).            High fuel level or float setting.            Fuel inlet needle not seating properly or worn needle and/or seat.            Ruptured accelerating pump diaphragm.            Excessive fuel pump pressure.</p>	<p>Defective power valve gasket.            Ruptured power valve diaphragm.            Loose fuel inlet needle valve seat or seat gasket damaged or missing.            Sticking and/or restricted float operation.            Float tab surface rough.            Dirt or foreign material in fuel holds float needle valve open.</p>
<b>Hard Starting</b>	<p>Incorrect setting of choke thermostatic spring housing.            Improper starting procedure, causing a flooded engine.            Improper carburetor fuel level.            Improper idle adjustments.            Sticking or incorrectly seating fuel inlet needle.            Incorrect fuel pump pressure.</p>	<p>Improper carburetor gasket and/or spacer combination.            Choke linkage or plate binding.            Binding or broken manual choke linkage.            Restrictions or air leaks in the choke vacuum or hot air passages.            Dirty air cleaner element.</p>
<b>Stalling</b>	<p><b>ENGINE HOT OR COLD</b>            Incorrect idle fuel mixture.            Engine idle speed too slow (fast or cold idle adjustments).            Dirt, water or ice in fuel filter.            Positive crankcase ventilation system malfunctioning or restricted.            Fuel lines restricted or leaking air.            Fuel tank vent restricted.</p>	<p>Leaking intake manifold or carburetor gaskets.            Carburetor icing (cold, wet or humid weather).            Incorrect throttle linkage adjustment to carburetor.            Clogged air bleeds or idle passages.            Defective fuel pump.            Excessive looseness of throttle shaft in bore(s) of throttle body.</p>
<b>Rough Idle</b>	<p>Improperly adjusted idle mixture screw.            Throttle plates and/or throttle shaft bent or damaged. Throttle plates misaligned.            Positive crankcase ventilation system malfunctioning or restricted.            Idle adjusting needle(s) grooved, worn or otherwise damaged.            Idle air bleeds restricted.            Idle air or fuel passages restricted.            Idle discharge holes not in proper relation to throttle plate(s).            Excessive dirt in air cleaner.            High or low fuel level or float setting.</p>	<p>Fuel inlet needle not seating properly, or worn needle or seat.            Power valve leaking.            Restricted air bleeds.            Plugged idle fuel channel restrictor.            Air leak at carburetor mounting intake manifold gasket.            Plugged main metering jet.            Accelerating pump discharge ball check or needle and/or weight not seating properly.            Fuel pump pressure too low, or excessive.            Fuel siphoning from secondary main fuel system.            Restriction in main fuel passage.            Air leak below carburetor or at intake manifold gasket.</p>
<b>Poor Acceleration</b>	<p>Poor acceleration complaints fall under one of three headings: the engine is sluggish on acceleration, the engine stalls when accelerated, or the engine hesitates or develops a flat spot when accelerated. Poor acceleration is caused by either an excessively lean or rich mixture on acceleration and/or defects or improper adjustments in the ignition system.</p>	<p><b>A Lean Mixture on Acceleration Can Be Caused by:</b>            Incorrect accelerating pump stroke adjustment.            Accelerating pump diaphragm defective.            Low fuel pump pressure.            Sticking fuel inlet needle.            Low fuel level or float setting. Restriction in main fuel passage.</p>

# CARBURETOR PROBLEM DIAGNOSIS

<b>Poor Acceleration (cont.)</b>	<p>Air leak between the carburetor and manifold caused by loose mounting bolts or defective gasket.</p> <p>Air leak at the throttle shaft caused by a worn throttle shaft.</p> <p>Accelerating pump fuel inlet valve not seating on acceleration.</p> <p>Restriction in the accelerating pump discharge passage.</p> <p>Accelerating pump discharge valve ball check or weight not coming fully off its seat, or failing to seat properly on the reverse stroke of the pump diaphragm.</p> <p>Air leak at the accelerating pump cover caused by a defective gasket or warped pump cover.</p> <p>Defective power valve spring.</p> <p>Defective secondary diaphragm.</p> <p>Air leak where secondary vacuum pick-up tube fits into air horn, between air horn and main body, or between the secondary diaphragm housing cover and housing.</p> <p>Secondary throttle plates wedged in barrels.</p> <p>Bent secondary throttle shaft.</p> <p>Secondary throttle plates operating rod</p>	<p>binding, or disconnected from secondary diaphragm or secondary throttle lever.</p> <p>Secondary vacuum passage ball check stuck on its seat.</p> <p>Secondary vacuum probe restricted or not properly positioned.</p> <p>Restricted secondary fuel passages.</p> <p>Power valve stuck.</p>
<b>Inconsistent Engine Idle Speed</b>	<p>Fast idle screw contacting low step of cam at curb idle.</p> <p>Incorrect throttle linkage adjustment to carburetor.</p> <p>Binding or sticking throttle linkage or accelerator pedal.</p> <p>Sticking carburetor throttle shaft.</p>	<p><b>A Rich Mixture on Acceleration Can Be Caused by:</b></p> <p>Broken power valve spring.</p> <p>Stuck or improperly adjusted secondary throttle air plates.</p> <p>High fuel level or float setting.</p> <p>Fuel inlet needle not seating properly or worn needle and/or seat.</p> <p>Malfunctioning automatic choke.</p> <p>Excessively dirty air cleaner.</p> <p>Incorrect accelerating pump stroke adjustment.</p> <p>Power valve leakage.</p> <p>Restricted air bleeds.</p> <p>Worn or damaged main metering jet.</p> <p>Excessive fuel pump pressure.</p> <p>Excessive looseness of throttle shaft in bores of throttle body.</p> <p>Sticking fuel inlet needle.</p> <p>Defective power valve or gasket.</p> <p>Air leak at carburetor mounting or intake manifold gasket.</p>
<b>Automatic Choke Slow Warm-Up, on Too Often or Long</b>	<p>Thermostatic choke setting too rich.</p> <p>Choke linkage sticking or binding.</p>	<p>Incorrect choke linkage adjustment.</p> <p>Choke plate misaligned or binding in air horn.</p>
<b>Surging (Cruising Speeds to Top Speeds)</b>	<p>Clogged main jets.</p> <p>Improper size main jets.</p> <p>Low fuel level or float setting.</p> <p>Clogged filter or filter screen.</p>	<p>Defective power valve or gasket.</p> <p>Distributor advance incorrect.</p> <p>Low fuel pump pressure or volume.</p>
<b>Reduced Top Speed</b>	<p>Excessive dirt in air cleaner.</p> <p>Improper size or obstructed main jets.</p> <p>Float setting too high or too low.</p> <p>Fuel pump pressure or volume too high or too low.</p> <p>Power valve spring weak, or power valve restricted.</p> <p>Restricted air bleeds.</p> <p>Restriction in main fuel passages.</p> <p>Throttle plates not fully open.</p> <p>Faulty choke operation.</p> <p>Improper throttle linkage adjustment.</p> <p>Air leak where secondary vacuum pick-up tube fits into air horn and main body,</p>	<p>or air leakage between the secondary diaphragm housing cover and housing or the air horn mounting gasket.</p> <p>Secondary diaphragm return spring too stiff.</p> <p>Secondary throttle plates wedged in barrels.</p> <p>Bent secondary throttle shaft. Secondary throttle plate operating rod binding.</p> <p>Secondary vacuum passage ball check sticking on its seat. Secondary damper linkage sticking. Distributor advance incorrect.</p>

# DUAL DIAPHRAGM FUEL PUMP

## Description

These pumps have 2 diaphragms (separated by a metal spacer) and a sight tube attached.

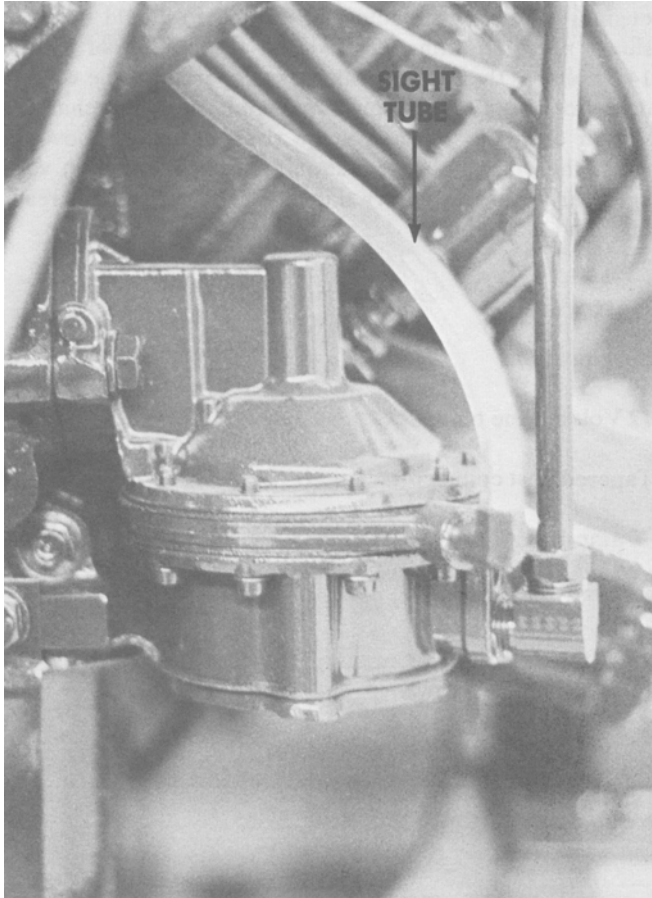

Dual diaphragm construction has 3 important safety features.

1. If main diaphragm fails, pump continues to function with second diaphragm.
2. No gasoline can leak outward from pump. It can leak only into space between diaphragms.
3. Gasoline in sight tube exposes defective pump.

Possibility of diaphragms failing simultaneously is remote, since they are composed of different materials and are shaped differently.

## Inspection

Dual diaphragm pump is not repairable and, therefore, must be replaced if defective. Inspect sight tube for fuel. If fuel is present, fuel pump is defective and must be replaced immediately.

## Cleaning Flame Arrestor

1. Remove nut and washer from center stud.
2. Remove flame arrestor from carburetor and wash it in solvent. Dry with compressed air and reinstall on carburetor.

## Cleaning Oil Filler Cap

1. Remove cap from valve cover.
2. Wash cap in solvent and dry with compressed air.

## Cleaning Crankcase Ventilating System

1. Remove ventilating valve from rocker arm cover and disconnect hose from valve.
2. Wash valve in solvent and dry with compressed air.
3. Disconnect hose from fitting (located in carburetor spacer) and clean inside diameter of hose and fitting.



# ELECTRICAL SYSTEM

At the connector plug of the engine wiring harness, at the rear of the engine, a short orange wire is provided which connects to the battery cable terminal of the starter solenoid. This wire is provided to shunt the alternator output directly to the battery, if a voltmeter is used in the instrument panel. If an ammeter is used in place of a voltmeter, disconnect the wire from the solenoid terminal, and snip it off close to the harness. It is advisable to cover the snipped-off end with plastic electrical tape to prevent a ground or short circuit from occurring. A voltmeter is recommended to be used in the instrument panel. While this is a slight departure from convention, it provides a three-fold advantage over the traditional ammeter.

1. By simply turning on the ignition key for a moment, it is possible to tell the charge condition of your battery.
2. By enabling the alternator output to shunt directly to the battery, rather than all the way to the instrument panel and back, there is virtually no current loss or line drop. In installations requiring an unusually long harness, such as houseboats, this is especially desirable.
3. Any overcharging tendency can be readily detected as an abnormally high voltage reading on the voltmeter, and corrections can be made before battery damage occurs.

Batteries tend to discharge when not in use, the rate of discharge varying with the condition of the battery itself and/or the entire electrical system.

When checking the battery condition, a normal average reading is 10 to 11.5 volts, after a reasonable period of disuse. If voltage reading is 10 volts or below, the battery should be charged by either a charging device or operation of the engine. Within one or two minutes after starting the engine, the voltage reading on the meter should begin to slowly rise, and ultimately level off at a reading of 13.5 to 14.5 volts, as the engine continues to operate. If the voltage does not rise after starting the engine, have the charging system checked. If the voltage rises and stays above 15 volts, the charging system should be checked. High voltages can result in battery damage, false instrument readings, and blown bulbs.

## Battery

### Specifications

12 Volt marine type

Tapered post connectors

70 amp-hr. minimum rating

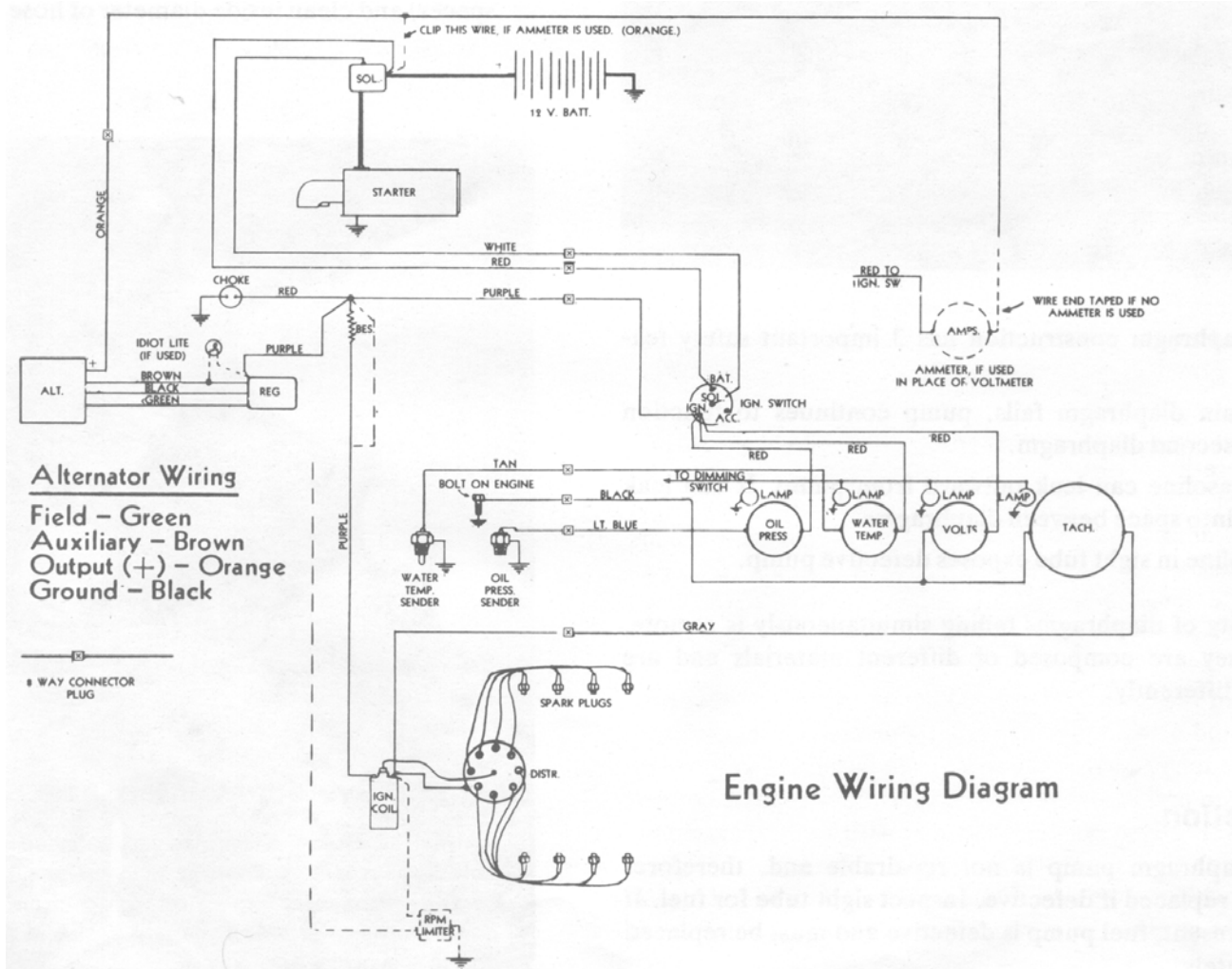

## Coil

The coil provided is used with an external ballast resistor, which is designed to control the internal temperature of the coil windings. The resistor cannot be repaired in any way, and if defective, must be replaced.

If the coil primary wires are removed from the terminals, be sure they are installed on the same terminals when replaced. If these wires are reversed, a reverse polarity situation occurs inside the coil which can decrease coil efficiency and life, and upset engine performance.

See wiring diagram for further details.

## Battery and Battery Cable Installation

1. Battery should be positioned as close to engine as possible and should be securely mounted in boat.
2. Connect negative (-) battery cable to ground on engine.
3. Connect positive (+) battery cable to solenoid.
4. Connect positive (+) battery cable to positive (+) post on battery and negative battery cable to negative (-) post on battery.

**CAUTION: Engine electrical system is negative ground. Failure to connect battery leads, as outlined, will damage system.**

## Battery Maintenance

**WARNING: Hydrogen and oxygen gases are produced during normal battery operation or charging. Sparks or flame can cause this mixture to ignite and explode, if they are brought near the vent openings. Sulphuric acid in battery can cause serious burns, if spilled on skin or in eyes. Flush or wash away immediately with clear water.**

Check battery with a hydrometer. If reading is below 1.230 (specific gravity), recharge or replace the present battery.

We recommend the use of a 12-volt marine battery with a 70 ampere-hour or larger capacity. Inspect battery and cables for signs of corrosion on battery, cables and surrounding area, loose or broken battery box, cracked or bulged cases, dirt and acid, electrolyte leakage and low electrolyte level. Fill cells to proper level with distilled water.

The top of the battery should be clean and the battery box and/or hold-down bolts properly tightened. Particular care should be taken so that the top of the battery is kept clean of acid film and dirt to prevent a short between the battery terminals. For best results, wash first with a dilute ammonia or soda solution to neutralize any acid present and then flush off with clean water. Care must be taken to keep vent plugs tight so that the neutralizing solution does not enter the cell.

To ensure good contact, the battery cables should be tight on the battery posts. If the battery posts or cable terminals are corroded, the cables should be cleaned separately with a soda solution and wire brush. After cleaning and before installing clamps, apply a thin coating of petroleum to the posts and cable clamps to help retard corrosion. If the battery has remained undercharged, the local servicing dealer should check for loose alternator belt, defective alternator, high resistance in the charging circuit or a low voltage output.

## The Charging System

Features a marine approved alternator with slip rings and brushes sealed in an ignition proofed metal case at the rear of the alternator. Two brushes carry current thru 2 slip rings to the rotor field coil. Stator windings are assembled on a laminated core which forms part of the frame. A rectifier plate connected to the stator contains 3 positive and one isolation diode. Three negative diodes which are pressed into the end frame are also connected to the stator windings. These diodes change the A.C. current produced by the alternator to D.C. current and directs it to the alternator output terminal. Field current is supplied and controlled by the voltage regulator which senses the alternator out-put from the Aux. terminal of the alternator. The alternator requires no maintenance because of the sealed type bearings used on the rotor which eliminates the need for periodic maintenance.

The solid state voltage regulator is non-adjustable. If the regulator proves defective, it must be replaced.

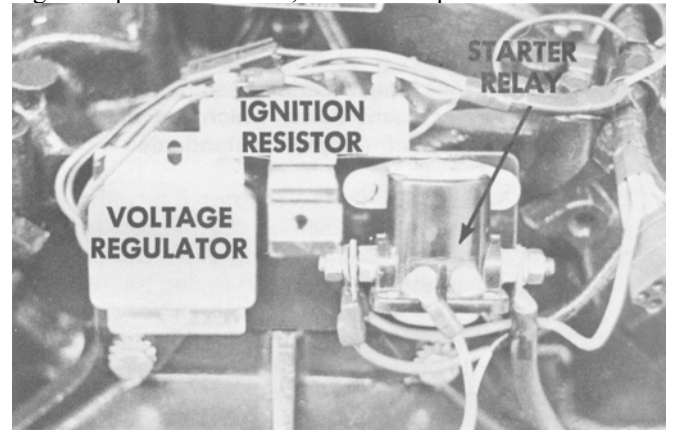

Provision is made in the charging circuit for the installation of a charge warning light, if it is desired.

Alternators and regulators should be serviced only by qualified personnel.

## Charging System Maintenance

**CAUTION: Since alternator is designed for only one polarity system, following precautions must be observed when working on charging circuit. Failure to observe these precautions will result in serious damage to electrical equipment.**

1. When installing battery, always be certain that ground polarity of battery and ground polarity of alternator are same.
2. When connecting a booster battery, make certain to connect negative (-) battery terminals together and positive (+) battery terminals together.
3. When connecting a charger to battery, connect charger positive lead to battery positive terminal and charger negative lead to battery negative terminal.
4. Do not short across or ground any terminals on alternator or regulator.
5. Do not attempt to polarize alternator.

## Inspection

Follow regular inspection procedure to obtain maximum life from alternator.

Frequency of inspection is determined largely by type of operating conditions.

1. At regular intervals, inspect terminals for corrosion and loose connections.
2. Check wiring for frayed or worn insulation.
3. Check mounting bolts for tightness.
4. Check belt for alignment, proper tension, apply pressure against stator laminations between end frames and not against either end frame.

## Ignition Distributor Inspection

**NOTE: Distributors on all PCM engines are marine approved and must meet marine specifications. Use only PCM Replacement Parts, which are manufactured to the same marine approved standards.**

**DANGER: Removal of the Distributor Cap must be accomplished by first loosening the screws which clamp the Distributor Cap retaining clips into place. Failure to loosen these screws and prying the retaining clips loose could damage the cap and/or destroy the ability of the cap to seal on the distributor causing the distributor to become vented and no longer sealed against possible ignition of fuel fumes if present.**



1. Remove distributor cap, clean cap and inspect for cracks, carbon tracks and burned-out or corroded terminals. Replace cap if necessary.
2. Make sure all distributor wire terminals are clean and tight.
3. Clean rotor and inspect for damage or deterioration. Replace rotor if necessary.
4. Inspect breaker assembly for damage, wear and dirty or badly pitted points.

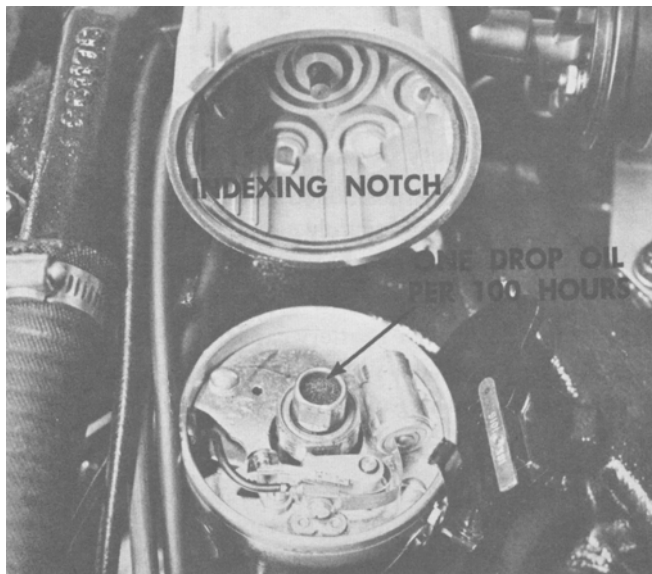

**NOTE:** Use notch on outer edge of distributor cap as a guide for proper replacement of cap. It is possible to install incorrectly. If installed incorrectly damage may occur and sealing of the cap to the distributor body will not properly occur.

## Lubrication

Remove distributor cap every 100 hours and apply a small amount of suitable high-melting-point, non-bleeding grease on distributor cam surface.

## Spark Plugs Inspection

1. Inspect each plug individually every 100 hours for badly worn electrodes, glazed, broken or blistered porcelain and replace where necessary.

**NOTE:** Spark plugs should be replaced after 200 hours of operation.

2. Inspect each spark plug for make and heat range. All plugs must be the same make and number or heat range.

**CAUTION: Never bend the center electrode to adjust gap. Always adjust by bending ground or side electrode.**



3. Adjust spark plug gaps with a round feeler gauge. (See "Specifications".) Replace defective plugs.
  4. Always keep spark plug seats in cylinder head clean.
  5. Install spark plugs to engine and torque to 15 ft. lbs. (2.07 mkg).
  6. Replace or repair any loose or damaged spark plug wires. Install all wires to proper spark plug. Proper positioning of spark plug wires in supports is important to prevent cross-firing
- NOTE:** Improper installation is one of the greatest single causes of unsatisfactory spark plug performance.

## SPARK PLUG DIAGNOSIS

Plug Conditions	Factors Causing This Condition	Corrective Action
Plug "Flash Over" (firing from upper terminal to base of plug)	Dirty insulator tops - oil, dirt and moisture on insulator will-shunt current to base of plug. The above condition can be caused by failure of spark plug boot.	Keep plugs wiped clean with cloth moistened with cleaning solvent. Check spark plug boot and replace if necessary.
Lead Fouling (light and powdery or shiny glazed coating on firing end)	By-products of combustion and fuel additives, deposited as a powder which may later melt and glaze on insulator tip.	Remove deposits by blast cleaning. If this is not possible, plugs should be replaced.
Damaged Shell	Very seldom occurs, but cause is almost always due to mishandling by applying excessive torque during installation. This failure is usually in the form of a crack in the Vee of the thread next to the seat gasket or at the groove below the hex.	Replace with a new spark plug.
Oil or Carbon Fouling	Wet, black deposits on firing end of plug indicate oil pumping condition. This is usually caused by worn piston rings, pistons, cylinders or sticky valves.  Soft, fluffy, dry black carbon deposits usually indicate a rich mixture operation, excessive idling, improper operation of automatic choke or faulty adjustment of carburetor. Hard, baked-on, black carbon deposits result from use of too cold a plug.	Correct engine condition. In most cases, plugs in this condition will be serviceable after proper cleaning and regapping. If troubles are not eliminated, use "hotter" type plug.  Use "hotter" type plug.
Normal Electrode Wear	Due to intense heat, pressure and corrosive gases together with spark discharge, the electrode wears and gap widens.	Plugs should be regapped every 100 hours.
Rapid Electrode Wear	Condition may be caused by (1) burned valves, (2) gas leakage past threads and seat gaskets, due to insufficient installation torque or damaged gasket, (3) too lean a mixture or (4) plug too "hot" for operating speeds and loads.	Correct engine condition. Install plugs to specified torque. Use a new spark plug seat gasket each time a new or cleaned spark plug is in-stalled. Use "colder" type plug if condition continues to exist.
Broken Upper Insulator (firing around shell crimp under load conditions)	Careless removal or installation of spark plug.	Replace with a new spark plug.
Broken Lower Insulator (firing tip)	The cause is usually carelessness in regapping by either bending of centerwire to adjust the gap or permitting the gapping tool to exert pressure against the tip of the center electrode or insulator when bending the side electrode to adjust the gap. Fracture or breakage of lower insulator also may occur occasionally if the engine has been operated under conditions causing severe and prolonged detonation or pre-ignition.	Replace with a new spark plug.  Use "colder" type plug for the particular type of operation.

# COOLING SYSTEMS

The cooling system of each PCM Marine Engine incorporates a full circulation bypass system, permitting a full flow of water through the engine, even during warmup. Two heavy-duty marine-type pumps are used to accomplish this. A flexible impeller supply pump is used to keep the system full, and cool the exhaust system; a high volume circulating pump maintains full water circulation to prevent steam pockets and hot spots, and assure longer valve and piston ring life. A heavy-duty thermostat is used to control the amount of water which is discharged from the engine after temperature is reached. The discharged water is automatically replaced by cool water from the supply pump, maintaining an unusually stable engine temperature through an exceptionally simple system. The hot water is discharged into the exhaust manifold water jackets, pre-heating the manifold to reduce condensation.

Should overheating occur, stop the engine immediately. Check the water intake for obstruction by weeds, etc. (Plastic sandwich bags and similar containers effectively close off a water intake - don't litter.) Check water pump drive belts for tension and slippage. Inspect water intake hoses for kinks and bends.

On inboard and vee-drive models, check the transmission oil cooler for obstruction of the water tubes.

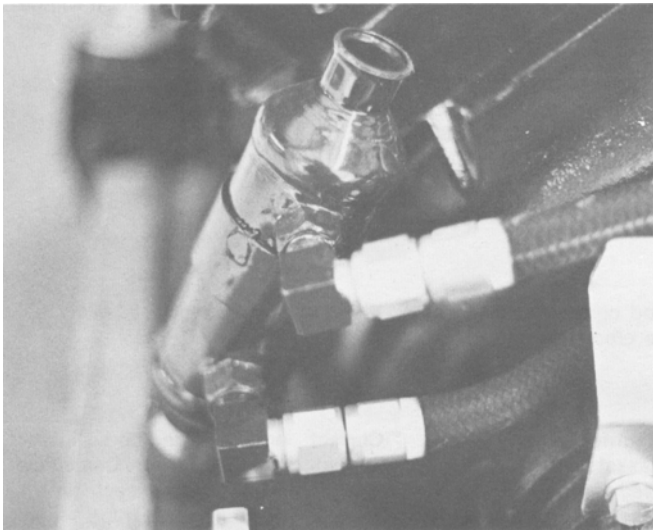

On all 255 H.P. models equipped with engine oil cooler, check the engine oil cooler for obstruction of the water tubes.

A partial inspection of the flexible impeller of the supply pump can be made by removing the top hose from the supply pump, and looking into the pump chamber while slowly turning the pump pulley. A badly damaged impeller should be readily detected in most cases.

If a problem is found and corrected, do not attempt to restart until the engine has cooled to normal limits.

See lay-up instructions for inspection and/or replacement of the supply pump impeller.

In freezing weather, the cooling system must be drained of all water to prevent damage. Drains are located on both sides of the engine block, exhaust manifolds, oil coolers, (if so equipped) and the elbow beneath the circulating water pump.

On inboard and vee-drive models, the drain on the transmission oil cooler should be opened or the lower hose removed.

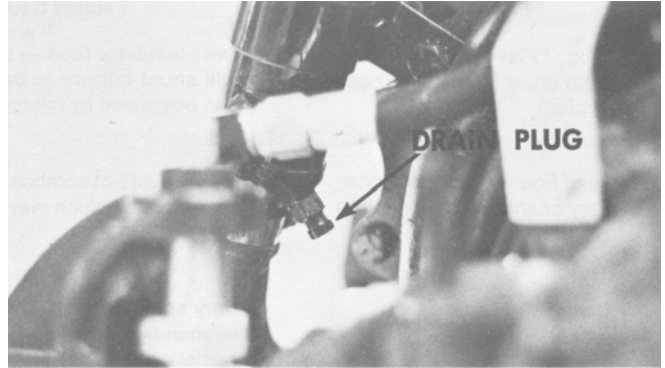

On all 255 H.P. models equipped with the engine oil cooler it should be drained.

On all fresh water cooled models, with closed cooling systems, an anti-freeze solution of 50% permanent type antifreeze, such as Zerex or Prestone should be used. This solution should be left in the system, and replaced once a year as an annual maintenance item. It is not necessary to drain these systems during freezing weather or lay-up, except for the following items:

- A. Exhaust Manifolds.
- B. Engine Oil Cooler - if so equipped.
- C. Transmission Oil Cooler - if so equipped.
- D. Raw Water Pump.
- E. Heat Exchanger - sea water portion only.
- F. All Hoses Which Carry Raw Water.

See Lay-up Instructions, Page **31** for full details.



## Flushing Instructions

**NOTE:** When engine is operated in salt water, flush it with fresh water periodically and before storage. If engine is flushed while boat is in water, water intake must have a sea water cock installed between water pickup and pump inlet.

**CAUTION: DO NOT operate engine without cooling water flowing through water pump, or water pump will be damaged, and subsequent engine damage may result.**

1. Close sea water cock (if flushed while boat is in water).
2. Remove hose clamp and inlet hose from water pump inlet.
3. Connect length of hose to pump inlet and city water tap and open tap.
4. Place the remote control lever in neutral position and start the engine. Operate the engine at 500 to 600 RPM in neutral gear until engine reaches normal operating temperature to circulate flushing water.
5. Check that water is being discharged out exhaust outlets and watch water temperature gauge on instrument panel to prevent overheating.
6. Allow engine to run until discharged water is clear.
7. Stop engine and remove flushing hose. Fasten water intake line securely to pump inlet with hose clamp.
8. Open sea water cock before restarting engine.

**IMPORTANT: DO NOT increase engine speed above 600 RPM or water pump damage may occur.**

## Closed Cooling System Filling

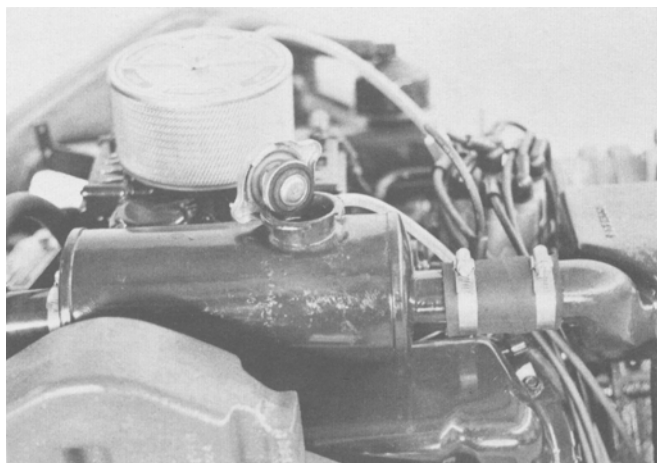

16 Qts. Capacity with 14 Lb. (6.35kg) Pressure Gap

1. Fill expansion tank with solution of clean water and permanent type anti-freeze. Mix to proportions of 50% water and 50% anti-freeze. If solutions are not

premixed, pour 2 gals. anti-freeze in system first and complete filling with water slowly until tank runs over.

2. Start engine and run for 5 minutes.  
**IMPORTANT: Do not operate engine without cooling water flowing through sea water pick-up pump, as pump will be damaged.**
3. Stop engine and check coolant level in expansion tank. Normal coolant level will fill expansion tank halfway. Add coolant, if necessary. If coolant level is above normal, excess will flow out overflow tube when engine reaches operating temperature.  
**IMPORTANT: Drain sea water section of cooling system if engine is removed from service in below freezing temperature.**
4. Check coolant level after first open-throttle boat test.

**CAUTION: Reservoir is equipped with a 14 lb. (6.35kg) pressure cap. To remove cap, turn a quarter of a turn to allow pressure in cooling system to escape. Then turn cap all-the-way off.**

Check coolant level periodically and add coolant if necessary. If level is excessively low, check system for leaks and repair as necessary.

Drain closed cooling system and fill with new coolant at least once each year.

## Draining Instructions

### Fresh Water Section

1. Remove fill cap from reservoir.

**CAUTION: Reservoir is equipped with a 14 lb. (6.35 kg) pressure cap. To remove cap, turn a quarter of a turn to allow pressure in cooling system to escape. Then turn cap all-the-way off.**

2. Remove drain plugs and open petcocks which are located as follows:

**Heat Exchanger** - One plug located in bottom of exchanger at the rear. Remove only the plug closest to the front of the engine.



**Cylinder Block** - Two plugs - one in each side of cylinder block.

**"Y" Fitting** - One plug.

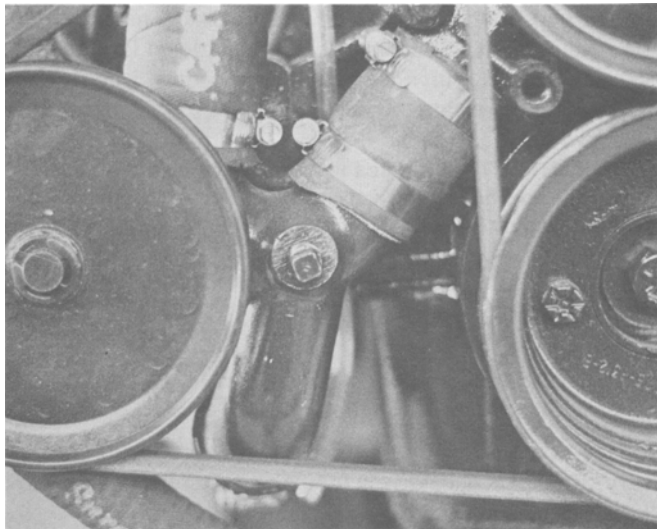

3. After system has drained completely, coat threads on plugs with sealing compound, reinstall plugs.

### Sea Water Section

1. Remove plug and anode from heat exchanger (rear).
2. Remove sea water intake hose from inlet side of sea water pickup pump.
3. Remove drain plugs from manifolds at front.
4. Remove plug from bottom of transmission cooler.
5. After system has drained completely, reinstall hoses and plugs. Coat threads on plugs with sealing compound before installing, then reinstall plugs.

### Cleaning Seawater Section of Exchanger

**NOTE:** It may be necessary to remove heat exchanger from engine to properly clean it.

1. Remove plug and anode from forward end and rearmost bottom of heat exchanger.

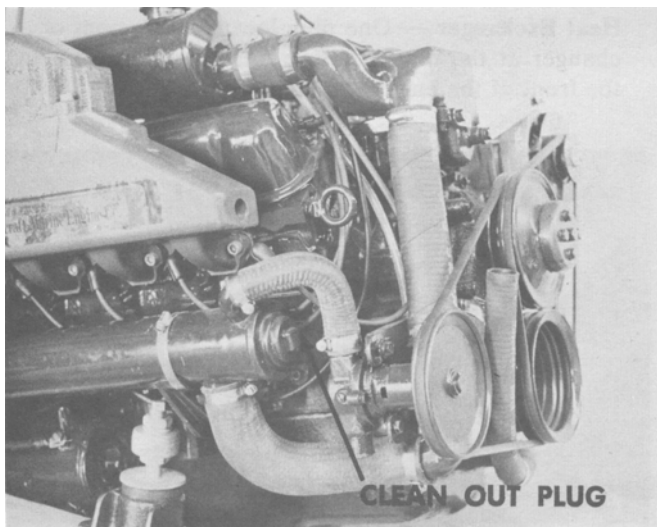

2. Clean water passages by inserting a suitable size brush thru them and flush with city water.

3. Seal plugs and replace in heat exchanger.
4. Tighten securely.
5. Fill system, according to procedure if heat exchanger is removed, and operate engine. Check for leaks.

### Adjusting Water Pump Drive Belt Tension

1. Check belt tension by depressing upper strand of belt at point midway between the two pulleys.
2. Belt should depress 1/4" (6.35mm). If depression is more than 1/4", adjust tension by loosening water pump mounting screws and pivoting pump, as required, to obtain correct tension.
3. After correct tension has been set, tighten mounting screws.

### Adjusting Alternator Drive Belt Tension

1. Check belt tension by depressing upper strand of belt at point midway between the alternator pulley and the circulating water pump pulley.
2. Belt should depress 1/4" (12.7mm). If depression is more than 1/4", adjust tension by loosening alternator mounting screws and pivoting alternator, as required, to obtain correct tension.
3. After correct tension has been set, tighten mounting screws.

### Lubrication System

#### Draining Engine Oil and Replacing Oil Filter

1. Run engine until temperature gauge indicates normal operating temperature. The benefit of draining is lost, to a large extent, if the crankcase is drained when the engine is cold, as some of the suspended foreign material will cling to the sides of the oil pan and will not drain out readily with the cold, slower-moving oil.
2. Pump oil out of oil pan thru dipstick tube with an oil drain pump. The dipstick tube extends to the bottom of the oil pan and is designed for this purpose on the 302 engine. A tube must be inserted through the dipstick tube on the 351 engine.
3. Remove filter from cylinder block. Be sure that old sealing ring is removed from cylinder block.
4. Coat sealing ring (located on new filter) with engine oil and thread filter on block. Tighten securely by hand.

5. Fill crankcase as outlined under "Filling Engine Crankcase", following, and check for oil leaks while engine is running.

### **Filling Engine Crankcase**

The engine crankcase capacity is approximately 5 qts. with a new, dry oil filter. Because of the effect the installed angle of the engine has on the oil level, the following procedure must be followed and the boat must be at rest in the water.

1. Pour oil into engine thru oil fill opening in rocker arm cover until level comes up to full mark on dipstick.
2. Start engine and run at idle speed for 5 minutes.
3. Stop engine and, after approximately 1 minute, check level on dipstick.
4. Add quantity of oil required to bring level up to full mark.

## **TRANSMISSION**

### **Description Reverse Gear Section**

The transmission consists of a planetary gear set, a forward clutch, a reverse clutch, an oil pump and a pressure regulator and rotary control valve. All are contained in a cast iron housing (along with necessary shafts and connectors) to provide forward, reverse and neutral operation.

A direct drive ratio is used for all forward operation. In reverse, speed of the output shaft is equal to input shaft speed, but in the opposite direction. Helical gearing is used to provide operation more quiet than can be obtained with spur gearing.

Shifting is accomplished by fore and aft movement of the shift lever. This movement rotates control valve and directs oil under controlled pressure to required channels.

Oil pressure is provided by the crescent type pump and drive gear which is keyed to the drive shaft. Pump operates at transmission input speed to provide screened oil to the pressure regulator.

From the regulator valve, oil is directed through proper circuits to bushings and anti-friction bearings which require lubrication. A flow of lubricant is present at the required parts whenever the front pump is turning, and it should be noted that supply is positive in forward, neutral and reverse conditions.

The unit has seals to prevent escape of oil.

Both input and output shafts are coaxial, with input shaft splined for installation of a drive damper, and output shaft splined for connecting to the coupling.

### **Precautions**

1. Oil cooler must be properly connected to transmission before engine is cranked or started. Failure to properly connect oil cooler will cause forward clutch piston to blow out from over-pressurization.
2. Change oil and clean oil screen once each season.
3. Check oil level at operating temperature.
4. Use clean containers for handling transmission fluid.
5. Fill transmission prior to starting engine.
6. Check oil level immediately after engine is shut off.
7. Use recommended automatic transmission fluids Type "A" Suffix "A" or new Dexron fluid.
8. Flush cooler and cooler lines after a transmission failure and prior to installing a new or rebuilt transmission.
9. Check engine alignment each time a transmission is replaced in boat.
10. Check shift linkage adjustment to insure that transmission shift lever is being positioned so that springloaded ball enters chamfered hole inside of shift lever in each selected position.
11. Check oil pressure and temperature when transmission functions indicate that a problem exists.
12. Always check pump rotation prior to assembling transmission to engine to ensure that pump is properly indexed for engine rotation.
13. Except in emergency, do not shift at engine speeds above 1200 RPM.
14. Never remove oil cooler lines or use smaller than recommended 13/32" (10mm) diameter cooler lines when operating transmission.
15. Do not permit propeller shaft to rotate when transmission is inoperative. Propeller shaft rotation could be caused by towing, sailing or operation of second engine which could move the boat through the water and cause propeller to "windmill".
16. (A thread sealant) must be used on pipe threaded hydraulic connections, to prevent hydraulic fluid from leaking.

### **Lubrication Recommendations**

The properties of the oil used in the transmission are extremely important to the proper function of the hydraulic system. Therefore, it is necessary that the recommended oil, automatic transmission fluid (ATF), Type "A", Suffix "A", be used. This fluid is currently known as "Dexron".

### **Procedure for Filling Transmission with Oil**

When filling transmission, add oil until it reaches full mark on dipstick. Quantity of oil depends upon angle of installation, but information to serve as a guide on possible amount needed may be found in chart following. Unit should be turned over at engine idle speed for a short time in order to fill all circuits, including cooler and cooler piping.

**NOTE: Be sure that cooler is properly installed and that transmission contains oil before cranking or starting.**

### Procedure for Checking Oil Level

Oil level should be checked immediately after stopping engine, and sufficient oil added to again bring transmission oil level to full mark on dipstick assembly. Dipstick assembly need not be threaded into case to determine oil level. Merely insert into case until cap or plug rests on surface surrounding oil filler hole.

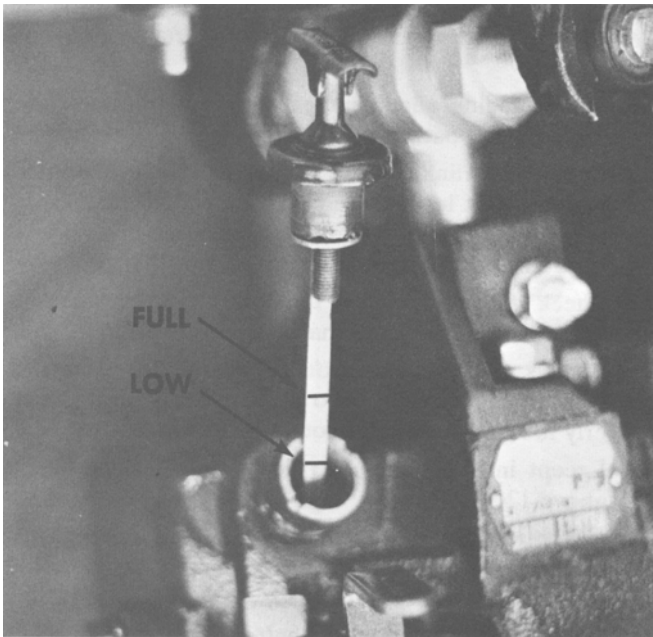

Transmission should be checked periodically to assure proper oil level, and oil should be added if necessary.

### Changing Oil

It is recommended that transmission oil be changed once each season. After draining oil from unit, thoroughly clean the removable oil screen before refilling transmission with recommended oil (ATF), Type "A", Suffix "A" "Dexron".

**NOTE:** Oil capacity does not include capacity needed for transmission cooler and oil lines, which may require an amount greater than in table, following.

### Draining Transmission Fluid and Cleaning Strainer Screen

The transmission drain and strainer screen, on engines equipped with direct drive transmissions, is located as shown in Figure . On engine equipped with reduction transmissions, drain and screen are located as shown in Figure

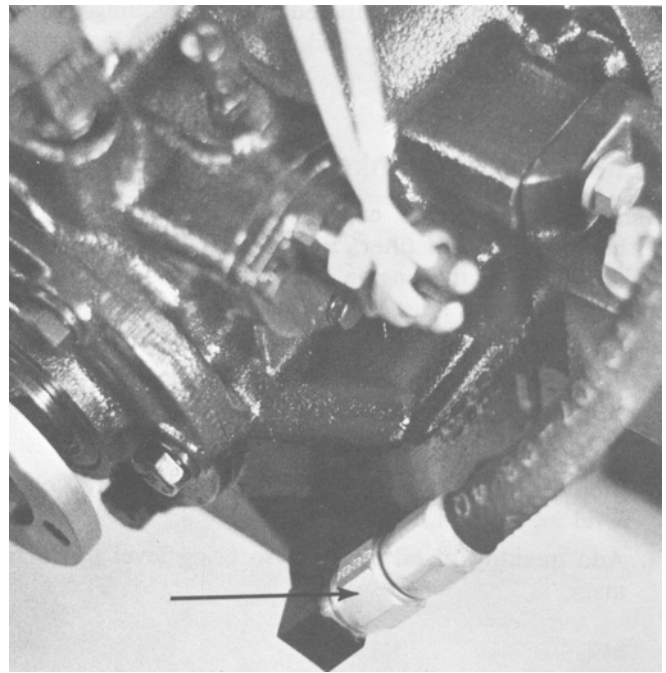

1. Place a suitable container under drain location.
2. Remove oil cooler hose from elbow.
3. Remove reducing bushing from transmission case and remove strainer screen.
4. Wash strainer screen with solvent and dry with compressed air.
5. After fluid has stopped draining, reinstall strainer, reducing bushing and oil cooler hose.
6. Fill transmission as outlined under "Filling Transmission", preceding.
7. Operate engine and check connections for leaks.

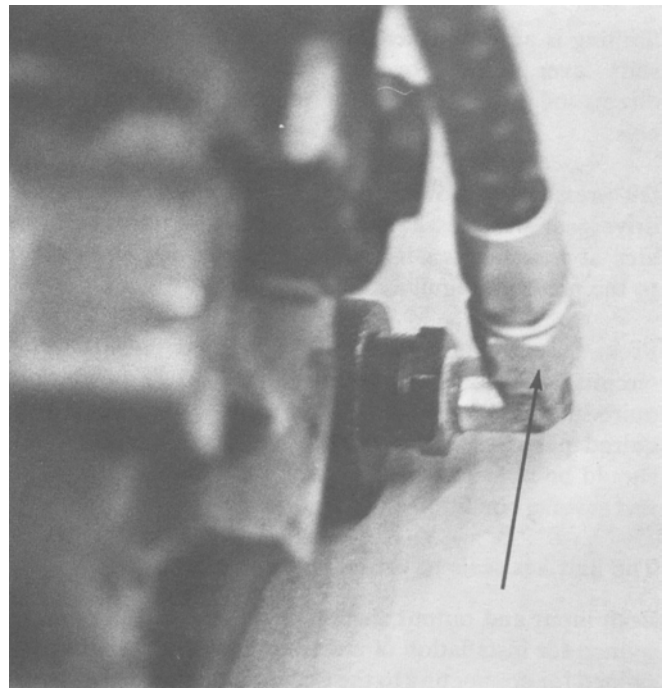

## Oil Capacity

Transmission Model	Transmission Oil Capacity Level	15° Inclined
AS 1-7C	1.8 Qts.	1.3 Qts.
Reduction Gears	2.5 Qts	2.7 Qts.
Vee Drives	1 Gal.	

## Filling Transmission

**IMPORTANT: Use only automatic transmission fluid Type "A", Suffix "A" in this transmission.**

1. Boat must be at rest in the water.
2. Remove dipstick which is located on port side of transmission case. (Figure )
3. Fill transmission thru this opening until fluid level comes up to the top mark on dipstick which is attached to plug.
4. After bringing fluid level up to the top mark tighten the dipstick.

5. Start engine and operate at idle speed for a short time to fill all circuits.
6. Stop engine and immediately check fluid level as outlined in Step 3. Add fluid, as required, to bring level up to the top mark on dipstick.
7. Place plug into case and tighten.

## V-Drive Transmission

1. On V-drive transmission, remove oil return line (upper hose) at oil cooler.
2. Place a suitable container under hose and lower hose below transmission. After fluid has stopped draining, reinstall cooler hose.
3. Fill transmission as outlined under "Filling Transmission", preceding.

**IMPORTANT: Oil level must be maintained at or slightly above full mark to insure lubrication reaching the V-drive section of the transmission.**

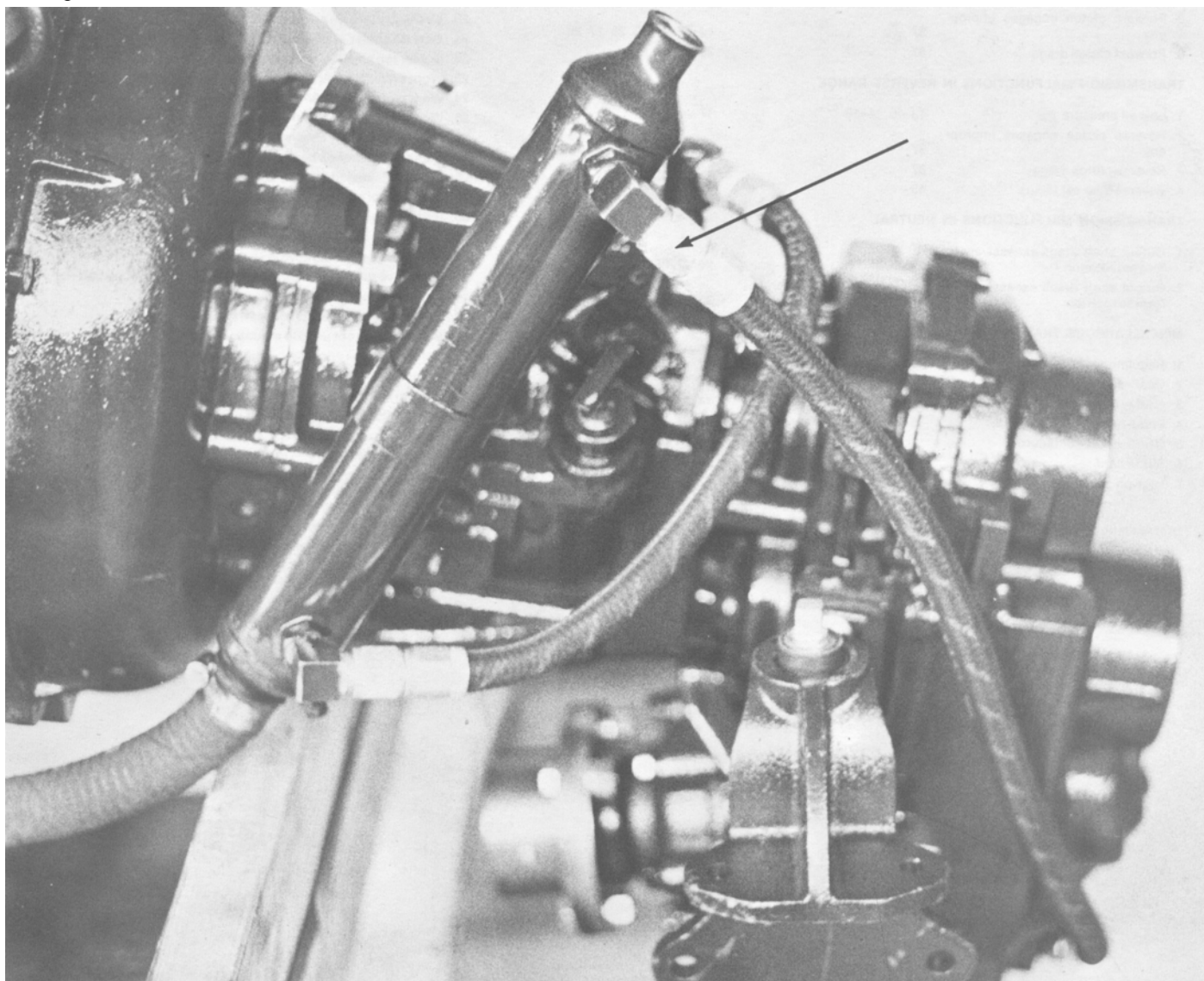

# WARNER GEAR TROUBLE SHOOTING CHART

COMPLAINTS & SYMPTOMS	REMEDY	
	Transmission in Boat	Transmission Removed
<b>INTERNAL &amp; EXTERNAL LEAKS</b>		
1. Oil leaks at pump		1 2 3 8
2. Oil on exterior of trans.	1 4 6 7	2 5 8
3. Oil leaks at rear bearing retainer	1 2 3 8	
4. Water in transmission oil or oil in cooling water	9	
5. Leaks at coupling	31 44	
6. Oil leaks out breather	15 19 22 40 45	17 23
<b>TRANSMISSION MALFUNCTIONS IN ALL RANGES</b>		
1. No oil pressure	10	11 12
2. Low oil pressure	13 15 16 18	17
3. High oil temperature	9 15 19 20 21 22	42
4. Failure of V-Drive gear		14 42 43
<b>TRANSMISSION MALFUNCTIONS IN FORWARD RANGE</b>		
1. Low oil pressure	13 15 16 18	17
2. Forward clutch engages improperly	37	12 23 24 25 26 27 28
3. Forward clutch drags	37	26 27 28
<b>TRANSMISSION MALFUNCTIONS IN REVERSE RANGE</b>		
1. Low oil pressure	13 15 16 18	17
2. Reverse clutch engages improperly	37	24 25 25 29
3. Reverse clutch drags	37	26 28 29
4. Reverse gear set failure	43	42
<b>TRANSMISSION MALFUNCTIONS IN NEUTRAL</b>		
1. Output shaft drags excessively in forward rotation	37	26 27 28
2. Output shaft drags excessively in reverse rotation	37	26 28 29 42
<b>MISCELLANEOUS TRANSMISSION PROBLEMS</b>		
1. Regulator valve buzz	30	
2. Gear noise-forward	31	14 32
3. Gear noise-reverse	31	14 32 42
4. Pump noise	15	17 32
5. Damper noise or failure		33 34 35 36
6. Shifts hard	16 39	7 37 38
7. High oil pressures	16 40 41	

\*If installation allows access, otherwise remove transmission

## KEY TO TROUBLESHOOTING CHART

1. Loose bolts -tighten
2. Damaged gasket
3. Damaged oil seal
4. Oil line fittings loose - tighten
5. Case leaks, porosity - replace
6. Oil filler plug or cap leaks-replace or tighten
7. Damaged control valve "O" ring
8. Foreign material on mating surfaces – clean
9. Damaged oil cooler, water and oil mixing - replace
10. No oil - check at once
11. Pump improperly located for engine rotation - locate correctly
12. Sheared drive key - replace
13. Faulty oil gauge - clean or replace, bleed air from gauge line
14. Bearing preload not properly adjusted
15. Low oil level - add oil to proper level
16. Regulator valve stuck - clean surfaces of burrs, dirt, or scoring. Polish inner bore with crocus cloth until valve moves freely
17. Worn oil pump - replace if necessary
18. Regulator spring weight low-replace
19. High oil level – drain oil to proper level
20. Low water level in cooling system
21. Dirty oil cooler- clean or replace
22. Cooler too small - replace with large cooler
23. Worn or misaligned bushing in transmission case - replace
24. Worn or damaged clutch piston oil seals
25. Worn or damaged clutch sealing rings
26. Clutch improperly assembled
27. Damaged or broken belleville spring
28. Worn or damaged clutch plate(s) - replace
29. Damaged or broken clutch springs
30. Regulator valve sticking
31. Inadequate torque on output shaft nut - tighten
32. Nicks on gears - remove with stone
33. Excessive runout between engine housing and crankshaft
34. Wrong damper assembly
35. Damaged damper assembly parts - replace
36. Body - fit bolts not used in mounting holes
37. Control linkage improperly adjusted
38. Control lever and poppet ball corroded - clean and lubricate
39. Control linkage interference - check
40. Wrong oil used in transmission - change
41. Cold oil
42. Planetary gear failure- replace or repair
43. Transmission operating in reverse when boat moves forward - selector must always be located over the "F" on side of case when boat is driven forward
44. Apply Permatex under coupling nut
45. External plumbing for cooler improperly connected



# LAY-UP INSTRUCTIONS

Long periods of storage can adversely affect the internal parts of the engine unless proper methods of preservation are used. Most marines or boat yards with storage facilities offer proper lay-up services. If such service is not available, or not to be utilized, the following procedures should be followed:

## (Prior to Haul-Out, a through e)

- Warm engine up to normal operating temperature. Stop engine.
- Change crankcase oil and oil filter. Remove flame arrestor.

**CAUTION: Be sure that engine compartment is well ventilated - and that there are no gasoline vapors present during this operation - to prevent engine fire.**

- Restart engine and allow to idle for 5 minutes.
- Shut off fuel supply from tank. With engine idling, slowly pour preservative oil, NUCLE.OIL, Shell VSI, or comparable oil, into carburetor air intake until engine stalls. **GREAT CARE SHOULD BE TAKEN NOT TO INTRODUCE OIL TOO RAPIDLY. HYDROSTATIC LOCKING COULD OCCUR WHICH WOULD SERIOUSLY DAMAGE THE ENGINE.**
- Turn off ignition, and remove spark plugs. Pour approximately 1 teaspoon full of oil into each cylinder, through the spark plug hole, and turn the crankshaft several revolutions to spread the oil evenly throughout the cylinder. Install spark plugs, but do not connect the spark plug wires. (It will be necessary to remove spark plugs and spin engine to eliminate all possible oil prior to restarting after lay-up period.)

## (After Haul-Out, f through q)

- Drain remaining fuel from carburetor bowl. Remove and empty the fuel filter shell, reinstall.
- Open drains on both sides of block.

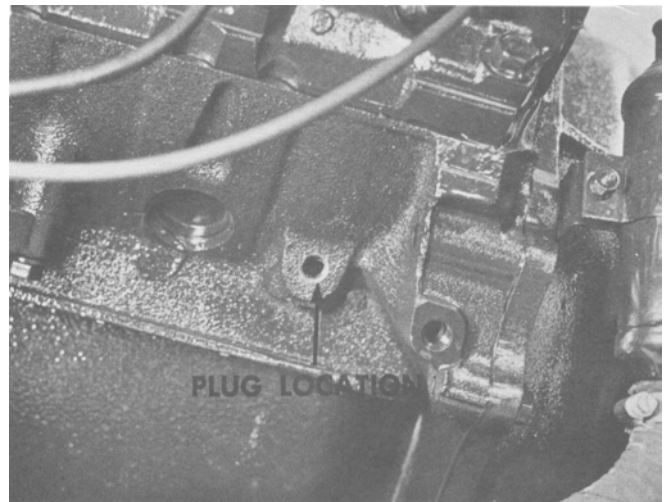
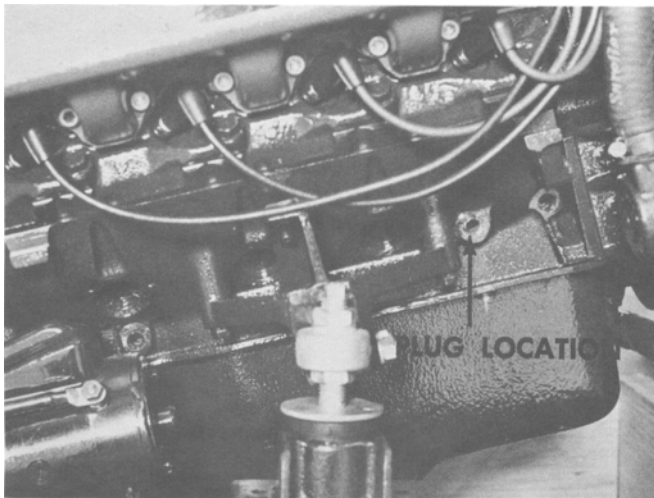

- Remove plug from the elbow between the thermostat housing and the circulating pump. See Fig.



- Remove drain plugs and/or hoses from rear of exhaust manifolds, both sides - (these should be left out until end of storage period). Flush both manifolds with a garden hose. (Block should also be flushed if run in salt water or water with high silt content. Allow to drain thoroughly.)

Probe holes with a short piece of wire to insure that all water is drained from the engine.

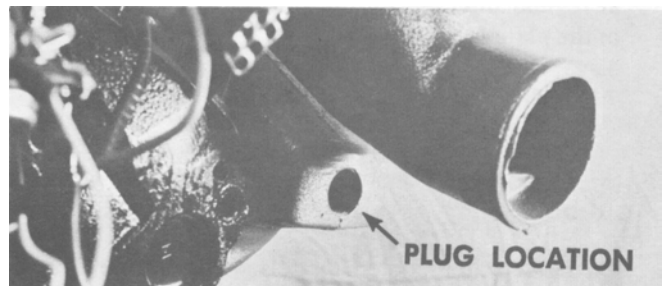

- When draining is completed, close the block drains and securely install the plug in the water pump elbow.
- Remove the hose from the upper connection on the raw water supply pump. Elevate the end of the hose to level higher than the top of the thermostat housing, and through the hose, fill the engine with a 50% solution of permanent antifreeze such as Zerex or Prestone. This helps to prevent the drying out of seals and gaskets, prevents the formation of hard, dry rust scale in the water jackets, and prevents freezing damage from isolated pockets of trapped water.



- l. When the system has been filled with antifreeze, reconnect and tighten the water hose.
- m. Disconnect the hose from the lower fitting of the raw water supply pump, and lower the end to eliminate any water which may be trapped.
- n. Remove the raw water supply pump, and remove the impeller. If inspection proves the impeller to be in good condition, store it in an accessible spot for reinstallation at the end of the storage period. A damaged or badly worn impeller should be discarded, and a new one installed at the end of the storage period. (Removal of the impeller during storage will prevent the impeller vanes from drying and taking a permanent "set".)
- o. Loosen water pump and alternator drive belts. (After lay-up, retighten to proper tension before starting engine.)
- p. Remove battery and store in an area where abovefreezing temperatures are maintained. Check electrolyte level and fill if temperatures are maintained. Batteries should be placed on a trickle charger or charged at regular intervals during storage to prevent sulfation of the plates.

**CAUTION: WHEN REINSTALLING THE BATTERY AFTER LAY-UP, BE SURE IT IS FULLY CHARGED, AND TAKE CARE NOT TO REVERSE THE TERMINALS. CONNECT NEGATIVE (-) TERMINAL TO GROUND.**

- q. On fresh water cooled models with antifreeze in the cooling systems, eliminate steps g, h, j, k and l. In step "i" remove hoses from the rear of the manifolds for draining. (Plugs referred to have been replaced with hose fittings on fresh water cooled models.) Drain raw water from heat exchanger, oil coolers and all raw water lines. Be sure the antifreeze solution is strong enough to offer full protection against freezing. Exhaust pipes and carburetor air intakes should be closed off during prolonged storage periods to minimize condensation inside the engine. Antifreeze should be changed after lay-up each year.

## Winter Storage of Batteries

1. Battery companies are not responsible for battery damage either in winter storage or in dealer stock if the following instructions are not complied with:
2. Remove battery from its installation as soon as possible and remove all grease, sulfate and dirt from top surface by turning a hose on top of battery. Be sure, however, that vent caps are tight beforehand, and blow off all excess water thoroughly with compressed air. Check water level, making sure that plates are covered.
3. When adding distilled water to battery, be extremely careful not to fill more than 3/16" (4.8mm) above perforated baffles inside battery. Battery solution or electrolyte expands from heat caused by charging. Overfilling battery will cause electrolyte to overflow (if filled beyond 3/16" above baffles).
4. Grease terminal posts well with cup grease or Multipurpose Lubricant and store battery in COOL-DRY place. Remove battery from storage every 30-45 days, check water level and put on charge for 5 or 6 hours at 6 amperes. DO NOT FAST CHARGE.
5. If specific gravity drops below 1.240, check battery for reason and recharge. When gravity reaches 1.260, discontinue charging. To check specific gravity, use a hydrometer, which can be purchased locally.
6. Repeat preceding charging procedure every 30-45 days, as long as battery is in storage, for best possible maintenance during inactive periods to insure a good serviceable battery in spring. When ready to place battery back in service, remove excess grease from terminals (a small amount is desirable on terminals at all times), recharge again as necessary and reinstall in your equipment.

**WARNING: Hydrogen and oxygen gases are produced during normal battery operation or charging. Sparks or flame can cause this mixture to ignite and explode, if they are brought near the vent openings. Sulphuric acid in battery can cause serious burns, if spilled on skin or in eyes. Flush or wash away immediately with clear water.**

## Recommissioning

1. Assemble water pump and reinstall on engine.
2. Install battery, being sure that it is in a fully-charged condition. Clean and lubricate terminals.
3. Check cooling system to be sure all hoses are properly attached.
4. Readjust alternator drive belt and water pump drive belt tension.
5. Check engine alignment.
6. Check engine and transmission oil levels.
7. Check engine mount fasteners.
8. Before starting, refer to "Starting and Operating" instructions, pages 6 & 14.

